

FM/AM Portable MiniDisc Recorder

Operating Instructions

Recorder Operation _____ **page 13**

Software Operation _____ **page 84**



Net MD



MDLP

"WALKMAN" is a registered trademark of Sony Corporation to represent Headphone Stereo products.  is a trademark of Sony Corporation.

MZ-NF610

WARNING

To prevent fire or shock hazard, do not expose the unit to rain or moisture.

Do not install the appliance in a confined space, such as a bookcase or built-in cabinet.

To prevent fire, do not cover the ventilation of the apparatus with news papers, table cloths, curtains, etc. And don't place lighted candles on the apparatus.

To prevent fire or shock hazard, do not place objects filled with liquids, such as vases, on the apparatus.

Certain countries may regulate disposal of the battery used to power this product. Please consult with your local authority.

Caution

The use of optical instruments with this product will increase eye hazard.

CAUTION — INVISIBLE LASER RADIATION WHEN OPEN

AVOID EXPOSURE TO BEAM

Information

IN NO EVENT SHALL SELLER BE LIABLE FOR ANY DIRECT, INCIDENTAL OR CONSEQUENTIAL DAMAGES OF ANY NATURE, OR LOSSES OR EXPENSES RESULTING FROM ANY DEFECTIVE PRODUCT OR THE USE OF ANY PRODUCT.

For customers who purchased this product in the USA

Owner's Record

The serial number is located at the rear of the disc compartment lid and the model number is located at the top and bottom. Record the serial number in the space provided below. Refer to them whenever you call upon your Sony dealer regarding this product.

Model No. MZ-NF610

Serial No. _____

Product registration

Please register this product on line at www.sony.com/walkmanreg
<<http://www.sony.com/walkmanreg>>

Proper registration will enable us to send you periodic mailings about software upgrades, new products, services and other important announcements. Thank you.

If you have any questions about this product, contact:

- <http://www.sony.com/walkmansupport>
- **Sony Network Portable Audio Support Line**
1-(866)-456-7669
- **Sony Customer Information Services Center**
12451 Gateway Blvd. Fort Myers, FL 33913

Declaration of Conformity

Trade Name: SONY

Model No.: MZ-NF610

Responsible Party: Sony Electronics Inc.

Address: 680 Kinderkamack Road,
Oradell, NJ 07649 USA

Telephone No.: 201-930-6972

This device complies with Part 15 of the FCC Rules. Operation is subject to the following two conditions: (1) This device may not cause harmful interference, and (2) this device must accept any interference received, including interference that may cause undesired operation.

This equipment has been tested and found to comply with the limits for a Class B digital device, pursuant to Part 15 of the FCC Rules. These limits are designed to provide reasonable protection against harmful interference in a residential installation. This equipment generates, uses, and can radiate radio frequency energy and, if not installed and used in accordance with the instructions, may cause harmful interference to radio communications. However, there is no guarantee that interference will not occur in a particular installation. If this equipment does cause harmful interference to radio or television reception, which can be determined by turning the equipment off and on, the user is encouraged to try to correct the interference by one or more of the following measures:

- Reorient or relocate the receiving antenna.
- Increase the separation between the equipment and receiver.
- Connect the equipment into an outlet on a circuit different from that to which the receiver is connected.

— Consult the dealer or an experienced radio/TV technician for help.

You are cautioned that any changes or modifications not expressly approved in this manual could void your authority to operate this equipment.

SONY MZ-NF610



**Tested To Comply
With FCC Standards**

FOR HOME OR OFFICE USE

For customers in the USA and Canada only

RECYCLING NICKEL METAL HYDRIDE BATTERIES

Nickel Metal Hydride batteries are recyclable.

You can help preserve our environment by returning your used rechargeable batteries to the collection and recycling location nearest you.



For more information regarding recycling of rechargeable batteries, call toll free 1-800-822-8837 or visit <http://www.rbrbc.org/>

Caution: Do not handle damaged or leaking Nickel Metal Hydride batteries.

The validity of the CE marking is restricted to only those countries where it is legally enforced, mainly in the countries EEA (European Economic Area).

- SonicStage, OpenMG and the OpenMG logo, MagicGate, Net MD and the Net MD logo are trademarks of Sony Corporation.
- Microsoft, Windows, Windows NT and Windows Media are trademarks or registered trademarks of Microsoft Corporation in the United States and /or other countries.
- IBM and PC/AT are registered trademarks of International Business Machines Corporation.
- Macintosh is a trademark of Apple Computer, Inc. in the United States and/ or other countries.
- MMX and Pentium are trademarks or registered trademarks of Intel Corporation.
- All other trademarks and registered trademarks are trademarks or registered trademarks of their respective holders.
- TM and ® marks are omitted in this manual.

Notice for users

On the supplied software

- Copyright laws prohibit reproducing the software or the manual accompanying it in whole or in part, or renting the software without the permission of the copyright holder.
- In no event will SONY be liable for any financial damage, or loss of profits, including claims made by third parties, arising out of the use of the software supplied with this recorder.
- In the event a problem occurs with this software as a result of defective manufacturing, SONY will replace it. However, SONY bears no other responsibility.
- The software provided with this recorder cannot be used with equipment other than that which is so designated.
- Please note that, due to continued efforts to improve quality, the software specifications may be changed without notice.
- Operation of this recorder with software other than that provided is not covered by the warranty.

Program © 2001, 2002 Sony Corporation
Documentation © 2003 Sony Corporation

Table of contents

Recorder Operations

Looking at controls	14
---------------------------	----

Getting started	18
-----------------------	----

Recording an MD right away!	22
-----------------------------------	----

Playing an MD right away!	25
---------------------------------	----

Listening to the radio	27
------------------------------	----

Various ways of recording	29
Viewing various information	29
To start/stop recording in sync with the sound source (Synchro-recording)	30
Long-time recording (MDLP)	31
Recording from a TV or a radio (Analog Recording)	32
Adding track marks while recording	33
Adding track marks manually	33
Adding track marks automatically (Auto Time Mark)	33
Adjusting the recording level manually	34

Various ways of playback	36
Viewing various information	36
Selecting the play mode	36
Playing a track repeatedly (Repeat Play)	37
Listening to selected tracks only (Bookmark Play)	37
Adjusting treble or bass (Digital Sound Preset)	38
Selecting the sound quality	38
Adjusting the sound quality	38

Editing recorded tracks	40
Before editing	40
Labeling recordings (Name)	40
Labeling	40
Moving recorded tracks (Move)	42
Dividing a track (Divide)	42
Dividing a track directly	43
Combining tracks (Combine)	43
Erasing tracks and a whole disc contents (Erase)	44
To erase a track	44
To erase the whole disc	45

Using the group function	46
What is the group function?	46
Recording tracks using the group function	46
Recording a track to a new group	46
Recording a track to an existing group	47
Playing groups	47
Playing a track in group play	47
Selecting the play mode for group play (Group Play Mode)	47
Repeat play for the selected group play mode (Group Repeat Play)	48
Editing groups	48
Assigning tracks or groups as a new group (Group Setting)	48
Releasing a group setting	49
Labeling recorded groups	50
Moving a track in a disc with group setting	50
Changing the order of a group on a disc (Group Move)	51
To erase a group	52

Other operations	53
Useful settings	53
How to use the menu items	55
Turning off the beep sound	56
Recording without overwriting existing material	56
Creating a new group when recording	56
Selecting the play mode	56
Adjusting treble or bass (Digital Sound Preset)	58
Starting the playback quickly (Quick Mode)	58
Protecting your hearing (AVLS)	59
Viewing various information	59
Labeling (Name)	60
Moving recorded tracks	60
Erasing tracks, the entire disc or groups (Erase)	61
Assigning tracks or groups as a new group (Group Setting)	62
Releasing a group setting	62

Various way to use the radio	65
Presetting radio stations automatically	65
Presetting radio manually	65
Listening to the preset radio stations	66
Receiving stations in another country	66

Power sources	67
Battery life	67

Additional information	68
Precautions	68
Specifications	70

Troubleshooting and explanations	72
Troubles and solutions	72
While charging	72
While recording	72
While playing	74
While Editing	75
While using group function	76
While using the radio	76
Others	77
Messages	78
Explanations	81

Software Operation

What is a Net MD?	85
-------------------------	----

Basic Operations	86
Basic operational flow using the Net MD	86
Providing the required system environment	87
System requirements	87
Installing the software onto your computer	88
Before installing the software	88
Installing SonicStage Ver.1.5	89
Connecting the Net MD to your computer	91
Storing audio data to your computer	92
Starting SonicStage	92
Recording audio CDs to the hard disk drive	93
Labeling audio data	95
Transferring audio data from your computer to the Net MD (Check-out)	96
Checking out audio files to the Net MD	96
Listening to an MD	99
Listening to an MD with the Net MD connected to the computer	99
Listening to an MD with the Net MD disconnected from the computer	99

Advanced operations	100
Using other functions!	100
Using the SonicStage online help	100

Other information	102
Settings and Precautions	102
Settings according to OS	102
For users with OpenMG Jukebox, SonicStage, or SonicStage Premium installed on their computer	104
Note on hard disk drive space	105
Notes on system suspend/hibernation mode	105
Backing up the audio data	105
Uninstalling the SonicStage software	106
For Windows XP users	106
For Windows Millennium Edition/Windows 98 Second Edition users	106
For Windows 2000 users	107
Troubleshooting	108
If your computer does not recognize the Net MD	110
If the installation was not successful	110
Information and explanations	112
Net MD FAQ	112
On copyright protection	114
Glossary	116
Index	118

Before using this product

This manual explains the recorder operations and the installation and basic use of the supplied SonicStage software. For details on the various operations, refer to the pages indicated below.

When using the recorder

Recorder Operation (pages 13 to 82)

Pages 13 to 82 in this manual explain the use of the Net MD as an ordinary MiniDisc Walkman.



Troubleshooting and explanations (page 72)

This section shows the troubles you may find while using the recorder, and their solutions.

When using the Net MD (the recorder) connected to your computer

Software Operation (pages 84 to 117)

Pages 84 to 117 in this manual explain the installation and basic operations of the supplied SonicStage software. Refer to these pages for details.

Other information (page 102)

This section shows the troubles you may find while using the SonicStage software, and their solutions. It also has the list of frequently asked questions and answers.

SonicStage Ver. 1.5 Help

This is an online help that you can view on your computer screen.

Refer to online help for details on the use of the software. To display the help window, see page 100.

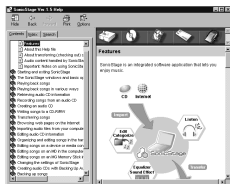

Notes on the "Software Operation" section

- The displayed items in the illustrations that appear in this section may differ from the actual items displayed by the software.
- Explanations in this section assume familiarity with basic Windows operations. For details on the use of your computer and the operating system, please refer to the respective manuals.
- Explanations in this section cover general Net MD products. For this reason, some explanations (and some illustrations) may not be applicable to your Net MD. Please refer to the operating instructions of your Net MD as well.

Checking the supplied accessories

AC power adaptor (1)

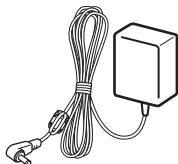

NH-7WMAA Nickel metal hydride rechargeable battery (1)

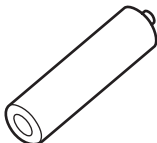

Headphones with a remote control (1)
(for USA model)

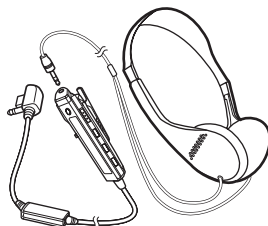

Earphones with a remote control (1)
(for Canadian model)

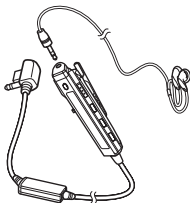

Dedicated USB cable (1)

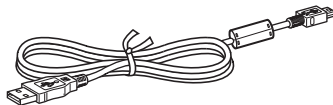

Battery carrying case (1)

CD-ROM (SonicStage Ver. 1.5) (1)*

*Do not play a CD-ROM on an audio CD player.

Looking at controls

The recorder

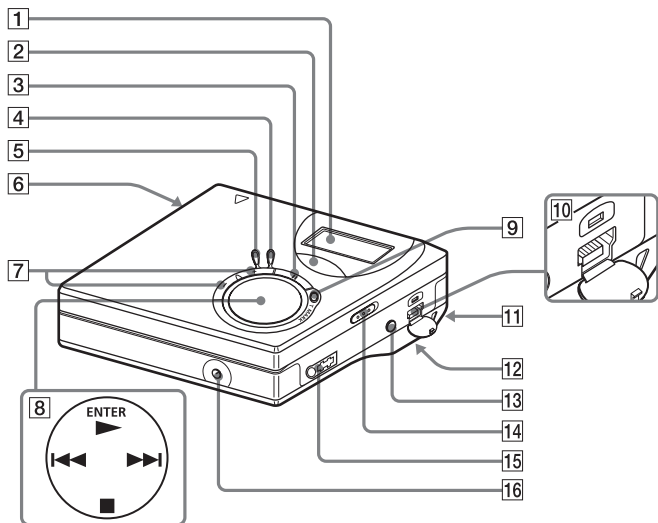

- 1** Display window
- 2** GROUP button
- 3** **||** (pause) button
- 4** END SEARCH button
- 5** MENU button
- 6** OPEN button
- 7** VOL +*, - button
* VOL + has a tactile dot.
- 8** 4-way control key
ENTER • ►*
◀◀, ▶▶ (search/AMS)
■ • CANCEL/CHG (stop/cancel/
charge)
* ► has a tactile dot.
- 9** REC (record) • T MARK button
- 10** USB connecting jack
- 11** Handstrap hole
Use the hole to attach your own strap.
- 12** Battery compartment (at the bottom)
- 13** LINE IN (OPTICAL) jack
- 14** HOLD switch
To prevent the buttons from being
accidentally operated when you carry
the recorder, use this function.
- 15** (headphones/earphones) jack
- 16** DC IN 3V jack

The display window of the recorder

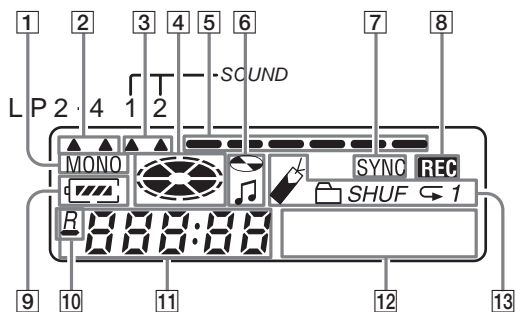

- | | |
|--|--|
| <p>1 MONO (monaural) indication</p> <p>2 LP mode indication</p> <p>3 Sound indications</p> <p>4 Disc indication
Shows that the disc is rotating for recording or playing an MD.</p> <p>5 Level meter
Shows the volume of the MD being played or recorded.</p> <p>6 Disc name/track name indication
Lights up when labeling a disc or a track.</p> <p>7 SYNC (synchro-recording) indication</p> <p>8 REC indication
Lights up while recording. When flashing, the recorder is in record standby mode.</p> | <p>9 Battery indication
Shows approximate battery condition.</p> <p>10 — : Indication for remaining playing time of the current track or of the disc
R : Indication for remaining recordable time of the disc</p> <p>11 Time display</p> <p>12 Character information display
Displays the disc and track names, error messages, track numbers, etc.</p> <p>13 Play mode indications
Shows the play mode (shuffle play, repeat play, group play, bookmark play, etc.) of the MD.</p> |
|--|--|

The headphones/earphones with a remote control

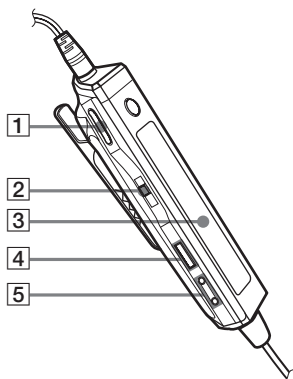

- 1** VOL +, - buttons
Press to adjust the volume.
- 2** Jog lever (◀◀ • ▶▶ ||/ENT • ▶▶▶, TUNE - • BAND • TUNE +)
 - ▶▶||/ENT (to press): play, pause, enter
 - ◀◀ (to slide towards): REW
 - ▶▶▶ (to slide towards): FF
 - BAND (to press): select a band
 - TUNE - (to slide towards): tune backward
 - TUNE + (to slide towards): tune forward
- 3** Display window
- 4** ■ (stop) button
- 5** ☞ (group) +, - buttons

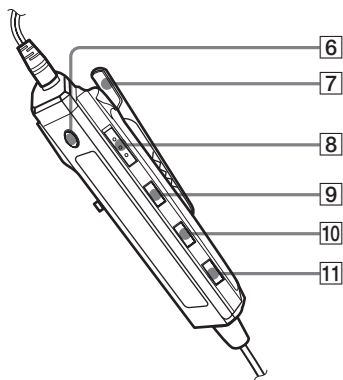

- 6** RADIO ON/OFF button
Press to turn on or off the radio.
- 7** Clip
- 8** HOLD switch
To prevent the buttons from being accidentally operated when you carry the recorder, use this function.
- 9** DISPLAY button
- 10** P-MODE/ ↶ button
- 11** SOUND button

The display window of the remote control

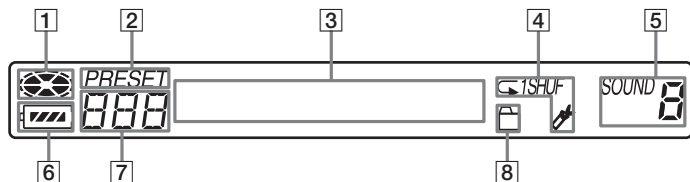

- | | |
|--|--|
| 1 Disc indication | 6 Battery level indication |
| 2 PRESET indication | 7 Track number/Band/Preset number display |
| 3 Character information display | 8 Group indication |
| 4 Play mode indication | |
| 5 SOUND indication | |

Getting started

Charge the rechargeable battery before using. Even if the rechargeable battery is not charged, you can use the recorder as long as the AC power adaptor is connected.

1 Insert the rechargeable battery

Slide OPEN to open the battery compartment lid.

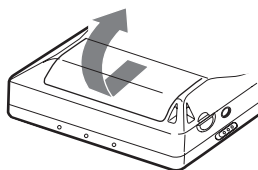

Insert the NH-7WMAA rechargeable battery minus end first.

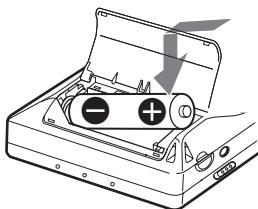

Close the lid.

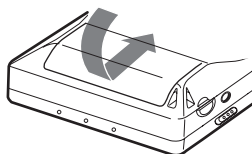

Using the dry battery

Insert one LR6 (size AA) alkaline dry battery (not supplied) instead of the rechargeable battery.

2 Charge the rechargeable battery.

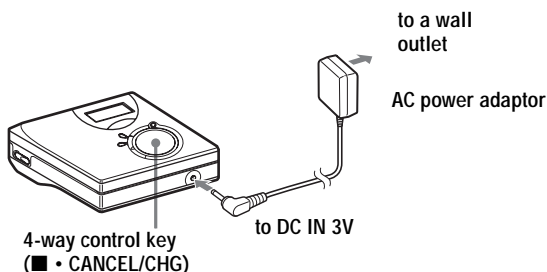

- 1 Connect the AC power adaptor to DC IN 3V.
- 2 Press ■ • CANCEL/CHG while the recorder is stopped.
“Charge” flashes,  appears in the display, and charging starts. When charging is completed, the battery indication disappears.
Full charging of a completely discharged rechargeable battery takes about 2 hours.
- 3 Disconnect the AC power adaptor.



For models supplied with the AC plug adaptor

If the AC power adaptor does not fit the wall outlet, use the AC plug adaptor.

Note

Charge the battery at a temperature of +5°C (+41°F) to +40°C (+104°F). The charging time may vary, depending on the surrounding temperature.

3 Make connections and unlock the controls.

1 Connect the headphones/earphones with the remote control to .

2 Slide HOLD to the opposite direction of the arrow () to unlock the controls.

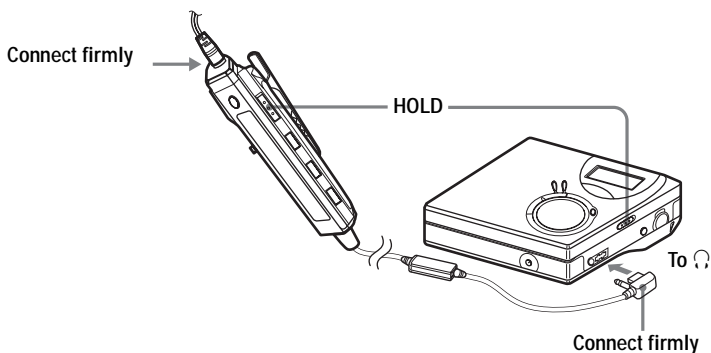

Battery life

For details, refer to “Battery life” (page 67)

When recording

(Unit: Approx. hours)

Batteries	SP Stereo	LP2 Stereo	LP4 Stereo
NH-7WMAA nickel metal hydride rechargeable battery	5.5	8	9
LR6 (SG) Sony alkaline dry battery	9	12	16

When playing

(Unit: Approx. hours)

Batteries	SP Stereo	LP2 Stereo	LP4 Stereo
NH-7WMAA nickel metal hydride rechargeable battery	14.5	15.5	17.5
LR6 (SG) Sony alkaline dry battery	36	42.5	48

When using the radio

(Unit: Approx. hours)

Batteries	FM/AM	TV/Wb(weather) (USA model only)
NH-7WMAA nickel metal hydride rechargeable battery	7.5	7
LR6 (SG) Sony alkaline dry battery	18.5	17

Recording an MD right away!

This section explains the basic procedure for making digital recordings using an optical cable connected to a CD player, Digital TV or other digital equipment. For other recording operations, see “Various ways of recording” (page 29).

Note that you cannot record a radio broadcast that is being received on the remote control.

1 Insert an MD.

① Press OPEN to open the lid.

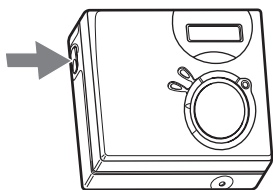

② Insert an MD with the label side facing front, and press the lid down to close.

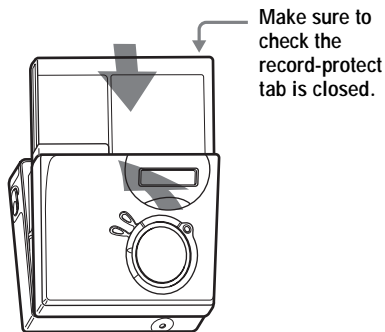

2 Make connections. (Insert the cables firmly and completely into the appropriate jacks.)

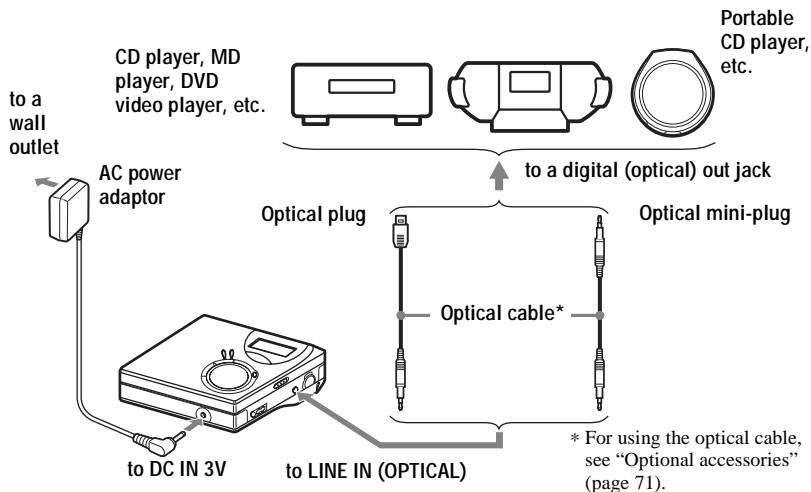

3 Record an MD.

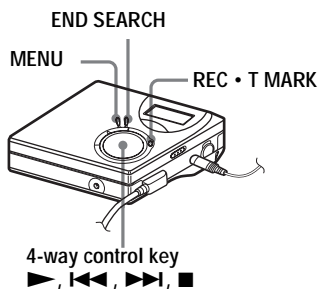

- 1 Set the sound source you want to record to pause.
- 2 While the recorder is stopped, hold down REC • T MARK and press ▶. The recorder starts recording.
- 3 Play the source you want to record. Track marks are automatically added at the same point as the sound source.

To stop recording, press ■.

Note

If you record on a previously recorded disc, the recorder is factory set to overwrite the entire contents of the disc. If you want the recording to start after the existing contents, do the procedure "Recording without overwriting existing material" (page 56) before doing step 3, "Record an MD." (page 23).

To	Press
Record from the end of the current contents ¹⁾	Press END SEARCH, press ► while holding down REC • T MARK ¹⁾ .
Record over partway through the previous recording ¹⁾	Press ► or press ◀◀ or ▶▶ to find the start point of recording, and then press ■ to stop. Press ► while holding down REC • T MARK.
Pause	Press ■ ²⁾ . Press ■ again to resume recording.
Remove the MD	Press ■ and open the lid. ³⁾ (The lid does not open while “TOC Edit” flashing in the display.)

¹⁾ If “R-Posi” is set to “Fr End”, recording operations will always start from the end of the previously recorded material without pressing the END SEARCH button (page 56).

²⁾ A track mark is added at the point where you press ■ again to resume recording while pausing; thus the remainder of the track will be counted as a new track.

³⁾ If you open the lid while “R-Posi” is set to “FrHere”, recording will begin from the top of the disc the next time you record. Check the point to start recording on the display.

If the recording does not start

- Make sure the recorder is not locked (pages 14, 20).
- Make sure the MD is not record-protected (pages 22, 69).
- Remastered MDs cannot be recorded over.

Notes

- Do not change the rechargeable battery during operation even if the recorder is connected to AC power adaptor. The operation may stop.
- “Edit” flashes while data of the recording (the track’s start and end points, etc.) is being recorded. Do not move the recorder or disconnect the power source while the indication is flashing in the display.
- If the power supply is disrupted (i.e. the battery is removed or becomes exhausted or the AC power adaptor is disconnected) during a recording or editing operation, or while “Edit” appears in the display, it will not be possible to open the lid until power is restored.

- Note the following when recording from a portable CD player:
 - Some portable CD players may not be capable of digital out when the AC power adaptor is disconnected. If this is the case, connect the AC power adaptor to the portable CD player and use it on AC power as the power source.
 - On some portable CD players, optical output may not be possible when using an anti-skip function (e.g., ESP* or G-PROTECTION). If this is the case, turn off the anti-skip function.
- * Electronic Shock Protection



- The recording level is adjusted automatically. To adjust the level manually, see “Adjusting the recording level manually” (page 34).
- You can monitor the sound during recording. Connect the headphones/earphones with remote control to and adjust the volume by pressing VOL + or -. This does not affect the recording level.

Playing an MD right away!

1 Insert an MD.

1 Press OPEN to open the lid.

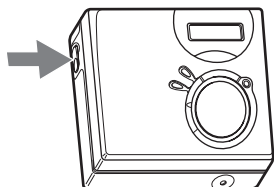

2 Insert an MD with the label side facing front, and press the lid down to close.

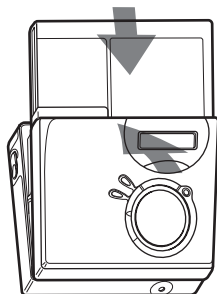

2 Play an MD.

4-way control key
(▶, ◀◀, ▶▶, ■)

VOL +, -

||

VOL +, -

Jog lever

(▶||, ◀◀, ▶▶, ◀)

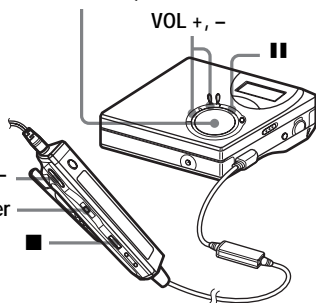

1 Press ▶ on the recorder.
(Press the jog lever (▶||) on the remote control.)

A short beep sounds in the headphones/earphones.

2 Press VOL + or - to adjust the volume.
The volume will be shown in the display.

To stop play, press ■.

A long beep sounds in the headphones/earphones when you operate. After you stop the recorder, the recorder will automatically turn off in about 10 seconds (when using batteries) or about 3 minutes (when using an AC power adaptor).

Playback starts from the point you last stopped playing.

To start with the first track of the disc, press ▶ on the recorder or the jog lever (▶||) on the remote control for 2 seconds or more.

To	Operation on the recorder	Operation on the remote control
Pause	Press . Press again to resume play.	Press the jog lever (▶). Press the jog lever (▶) again to resume play.
Cue to the current track or the previous track	Press ◀◀ . Press ◀◀ repeatedly.	Slide the jog lever towards ◀◀ . Slide the jog lever towards ◀◀ repeatedly.
Cue to the next track	Press ▶▶ .	Slide the jog lever towards ▶▶ .
Go backwards or forward while playing	Press and hold ◀◀ or ▶▶ .	Slide and hold the jog lever towards ◀◀ or ▶▶ .
Search for a specific position while viewing a elapsed time (Time Search)	Press and hold ◀◀ or ▶▶ while pausing.	Slide and hold the jog lever towards ◀◀ or ▶▶ while pausing.
Search for a specific track while viewing track names and numbers (Index Search)	Press and hold ◀◀ or ▶▶ while the recorder is stopped.	Slide and hold the jog lever towards ◀◀ or ▶▶ while the recorder is stopped.
Cue to the beginning of the every 10th track (only during playback of the disc with no group settings ¹⁾)	Press GROUP, and then press ◀◀ or ▶▶ .	Press ⏪ + or – button
Remove the MD	Press ■ and open the lid. ²⁾	Press ■ and open the lid.

¹⁾ For more details, see “Using the group function” (page 46).

²⁾ Once you open the lid, the point to start play will change to the beginning of the first track.

If the play does not start

Make sure the recorder is not locked (pages 14, 20).

Note

The playback sound may skip if:

- the recorder receives stronger continuous shock.
- a dirty or scratched MD is played.

Listening to the radio

You can listen to the radio through the built-in digital tuner in the remote control. With the USA model, you can also listen to TV and weather broadcasts.

You cannot use the recorder to record a radio broadcast that is being received on the remote control.

1 Turn on the radio.

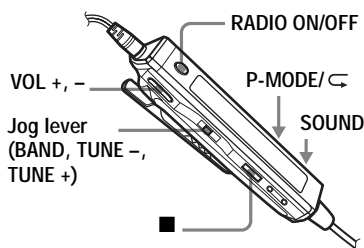

- 1** Press RADIO ON/OFF.
The radio turns on.
If "PRESET" is displayed, press P-MODE/◀ to make it disappear from the display.
- 2** Press the jog lever repeatedly to select the band.
Each time you press the jog lever, the indication changes as follows:
USA model: "FM" → "AM" → "TV" → "Wb" (weather)
Canadian model: "FM" → "AM"
- 3** Slide the jog lever towards TUNE + or TUNE - repeatedly to tune in the desired radio station.
- 4** Press VOL +, - to adjust the volume.

To turn off the radio
Press RADIO ON/OFF or ■.

To tune in a station quickly
In step 3, slide and hold the jog lever until the frequency indication begins to change. The remote control automatically scans the radio frequencies and stops when it finds a clear station.

To improve the broadcast reception

- For FM/TV/Wb (weather): Extend the headphones/earphones cord, which act as the FM antenna.
- For AM: Orient the built-in AM antenna inside the remote control horizontally to obtain optimum AM reception.

If an FM broadcast is hard to tune in

Press SOUND repeatedly until "Local" appears in the display. The noise will be reduced.

When you cannot operate the radio

Make sure the remote control is not locked (page 16, 20).

Notes

- There is a DC-DC converter attached to the remote control cord.

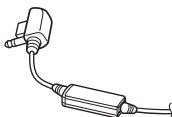

When listening to an AM program, keep the remote control away from the DC-DC converter, otherwise, noise may be heard.

- When you use the radio, it is recommended that you use a fully charged rechargeable battery or a new dry battery since more power is consumed by the radio than by MD playback.
- The radio will not operate if the remote control is not connected to the recorder.
- Do not place the remote control close to another electronic device, such as the recorder itself, another radio, a TV, a mobile phone, or a computer, as this may cause noise in the reception.
- Playback or recording stops when you use the radio.

- The volume of radio and MD can be adjusted individually using the supplied remote control.

Viewing various information

You can check the remaining time, track number, etc. when recording or during stop. Group-related items appear only when a track with group settings is played and then stopped.

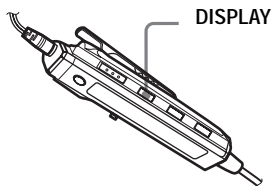
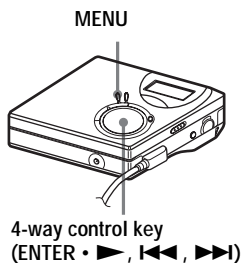

On the recorder

- 1 Press MENU.
- 2 Press ◀◀ or ►► repeatedly until "DISP" appears in the display, and then press ENTER.
- 3 Press ◀◀ or ►► repeatedly until the information you want appears in the display, and then press ENTER. Each turn changes the display as follows:
LapTim → RecRem →
GP Rem → AllRem

Display window on the recorder



When you press ENTER, **A** and **B** appear in the display.

Display: **A/B**

B (selected item)	A	B (After a few seconds)
— LapTim	Elapsed time	Track number
RecRem	Remaining time for recording	Track number
GP Rem	Remaining time after the current track in a group	Group name
AllRem	Remaining time after the current location	Disc name

Note

Depending on whether the group function is used or not, the operating conditions, and the disc settings, you may not be able to select certain indications or the indications may appear different.

On the remote control

1 Press DISPLAY.

Each time you press the button, the display changes as follows:

Display window on the remote control

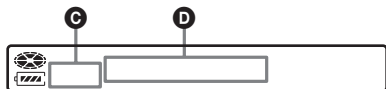

Display: C/D

C	D
Track number	Elapsed time
Track number	Track name
The number of the track in the group	Group name
The number of tracks in the disc	Disc name
Track number	The name of the sound mode

Note

Depending on whether the group function is used or not, the operating conditions, and the disc settings, you may not be able to select certain indications or the indications may appear different.



For more details about the indications in the display while playing, see “Viewing various information” (page 36).

To start/stop recording in sync with the sound source (Synchro-recording)

During synchro-recording, the recorder starts and stops recording in sync with the sound source. When recording from digital equipment (such as a CD player), you can omit operating both the recorder and the sound source, and easily make digital recording. You can make synchro-recording only when the optical cable is connected.

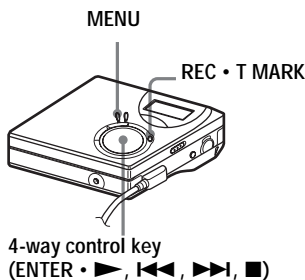

- 1** Make connections.
Use the appropriate optical cable to suit the source equipment. Connect the cable firmly to the appropriate jacks.
- 2** While the recorder is stopped, press MENU.
- 3** Press **◀◀** or **▶▶** repeatedly until “R-SET” appears in the display, and then press ENTER.
- 4** Press **◀◀** or **▶▶** repeatedly until “SYNC-R” appears in the display, and then press ENTER.
- 5** Press **◀◀** or **▶▶** repeatedly until “ON” appears in the display, and then press ENTER.

- 6 Press **▶** while pressing REC • T MARK.

The recorder stands by for recording.

- 7 Play the source you want to record.

The recorder starts recording automatically when it receives the playing sound. “REC” light up in the display.

To stop recording

Press **■**.



When there is no sound from the player for about 3 seconds during synchro-recording, the recorder goes into the standby mode automatically. When the sound comes from the player again, the recorder resumes synchro-recording. If the recorder is kept in the standby mode for 5 minutes or longer, the recorder stops automatically.

Notes

- The pause function cannot be turned on or off manually during synchro-recording. Press **■** to stop recording.
- Do not switch the “SYNC-R” setting while recording. Recording may not be done properly.
- Even when there is no sound on the sound source, there may be cases when recording does not pause automatically during synchro-recording due to the noise level emitted from the sound source.
- If a silent portion is encountered for approximately 2 seconds during synchro-recording from a sound source other than a CD or an MD, a new track mark is automatically added at the point where the silent portion ends.

Long-time recording (MDLP)

Select each recording mode according to the recording time that you want. Stereo recording is possible at 2 times (LP2) or 4 times (LP4) the normal (stereo) recording time. Monaural recording at 2 times normal recording time is also possible.

MDs recorded in monaural, LP2, or LP4 mode can be played back only on MD players or recorders with monaural, LP2, or LP4 playback mode.

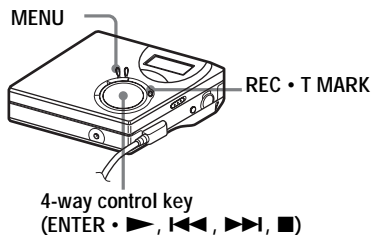

- 1 Press MENU.
- 2 Press **◀◀** or **▶▶** repeatedly until “R-SET” appears in the display, and then press ENTER.
- 3 Press **◀◀** or **▶▶** repeatedly until “R-MODE” appears in the display, and then press ENTER.

- 4 Press **◀◀** or **▶▶** repeatedly to select the desired recording mode, and then press **ENTER**.

Recording mode ¹⁾	Display window on the recorder	Recording time ³⁾
SP stereo	SP	Approx. 80 min.
LP2 stereo	LP2	Approx. 160 min.
LP4 stereo	LP4	Approx. 320 min.
Monaural ²⁾	MONO	Approx. 160 min.

¹⁾ For better sound quality, record in normal stereo (stereo) or LP2 stereo mode.

²⁾ If you record a stereo source in monaural, the sounds from left and right will be mixed.

³⁾ When using an 80-minute recordable MD

- 5 Press **▶** while pressing **REC • T MARK**.

The recording starts.

- 6 Play the source you want to record.

To stop recording

Press **■**.

The recorder keeps the setting of the recording mode when you record the next time.



Audio components that support the LP2 stereo or LP4 stereo modes are indicated by the **MDLP** or **MDLP** logo marks.

Notes

- It is recommended that you use the AC power adaptor for long recordings.
- When you record in LP4 mode, momentary noise may be produced on very rare occasions with certain sound sources. This is because of the special digital audio compression technology that enables a recording time 4 times longer than normal. If noise is produced, it is recommended that you record in normal stereo or LP2 mode to obtain better sound quality.

Recording from a TV or a radio (Analog Recording)

This section explains how to record from an analog equipment such as a cassette recorder, a radio, or TV.

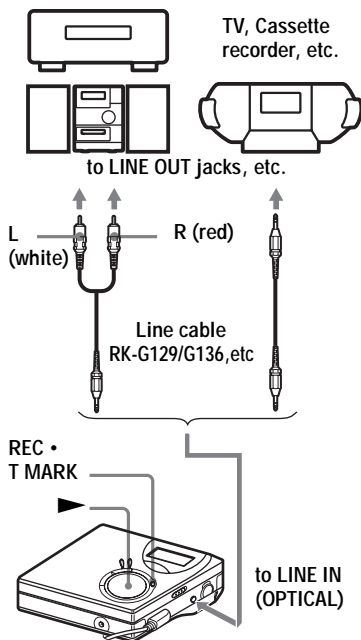

- 1 Make connections.
Use the appropriate connecting cord to suit the source equipment*. When connecting the cable, make sure to insert the connectors firmly.

* For details, see "Optional accessories" (page 71)

- 2 Press **▶** while pressing **REC • T MARK**.
The recording starts.
- 3 Play the source you want to record.

Adding track marks while recording

You can add track marks (track number) while recording.

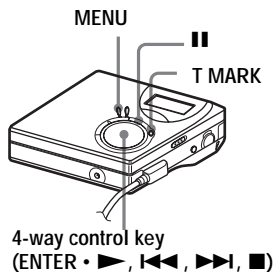

Adding track marks manually

- 1 While the recorder is recording, press **T MARK** (press **P-MODE/↶** on the remote control).

Adding track marks automatically (Auto Time Mark)

Use this feature to add track marks automatically at specified intervals when recording through the analog input connector. This function is convenient for recording long period of time, such as lectures, meetings, etc.

- 1 While the recorder is recording or in recording pause, press **MENU**.
- 2 Press **◀◀** or **▶▶** repeatedly "R-SET" appears in the display, and then press **ENTER**.
- 3 Press **◀◀** or **▶▶** repeatedly "TimeMk" appears in the display, and then press **ENTER**.
"OFF" appears in the display.
- 4 Press **▶▶** to show "ON" in the display, and then press **ENTER**.
- 5 Press **◀◀** or **▶▶** repeatedly until the desired time interval appears in the display, and then press **ENTER**.
Pressing **◀◀** or **▶▶** changes the time setting (Time:) by 1 minute, within the range of 1 to 99 minutes.

To cancel Auto Time Mark
Select "OFF" in step 4 or stop recording.

Using Auto Time Mark to add track marks while recording

When the elapsed recording time exceeds the time interval for Auto Time Mark:

The recorder adds track marks at the point you set the time interval and from that point the recorder adds a track mark whenever the time interval has elapsed.

Example: Eight minutes of recording has been completed when the Auto Time Mark time interval is set to 5 minutes. A track mark will be added at the 8-minute point (after the start of recording) and after each 5-minute interval thereafter.

When the time interval set for Auto Time Mark exceeds the elapsed recording time:

The recorder adds track marks when the set Auto Time Mark time interval has elapsed.

Example: Three minutes of recording has been completed when the Auto Time Mark time interval is set to 5 minutes. A track mark will be added at the 5-minute point (after the start of recording) and after each 5-minute interval thereafter.



“T” appears after the track display on the recorder for track marks added by Auto Time Mark.

Notes

- If you add a track mark by pressing T MARK or **||** (pause), etc, while recording, Auto Time Mark will begin automatically adding a track mark each time the selected time interval has elapsed.
- The setting will be lost when the recording stopped.

Adjusting the recording level manually

The sound level is adjusted automatically while recording. If necessary, you can set the recording level manually during both analog and digital recording.

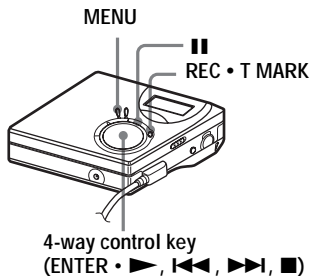

- 1 While pressing **||**, press REC • T MARK.
The recorder stands by for recording.
- 2 Press MENU.
- 3 Press **◀◀** or **▶▶** repeatedly until “R-SET” appears in the display, and then press ENTER.
- 4 Press **◀◀** or **▶▶** repeatedly until “RecVol” appears in the display, and then press ENTER.
- 5 Press **◀◀** or **▶▶** repeatedly until “Manual” appears in the display, and then press ENTER.
- 6 Play the source.

- 7 While observing the level meter in the display, adjust the recording level by pressing ◀◀ or ▶▶.

Set the level so that the maximum input lights up the fifth segment on the level meter.

If the sixth segment lights up, lower the level by pressing ◀◀.

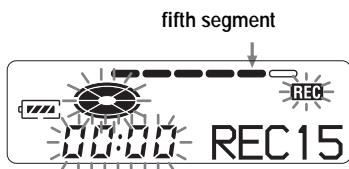

Recording does not start in this step. If your source is an externally connected component, be sure to cue the source to the beginning of the material to be recorded before you start playback.

- 8 Press ■ again to start recording.

To switch back to automatic level control

Select "Auto" in step 5.

Notes

- You cannot adjust the left and right channel levels separately.
- Once you stop recording, the recorder will revert to automatic recording level adjustment mode the next time you start a recording operation.
- To adjust the recording level manually during synchro-recording, do steps 1 to 7 of the procedure in this section with "SYNC-R" is set to "OFF". Then change the "SYNC-R" setting to sync "ON", and start recording (page 30).

In this section, the operation using the remote control is mainly explained. For details on operations done on the recorder, see the pages indicated for each operation.

Viewing various information

You can check the track or disc name, track number, the elapsed playing time of the current track, the number of the tracks recorded on the MD, the group name, and the total number of tracks in a group.

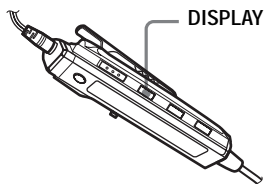

- 1 While playing, press DISPLAY. Each time you press DISPLAY, the display changes as follows:

Display window on the remote control

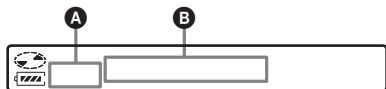

Display: A/B

A	B
Track number	The elapsed time
Track number	Track name
The number of total tracks in the group	Group name
The number of total tracks	Disc name
Track number	Sound mode

A	B
Track number	SP/LP mode

Notes

- Depending on whether group play or normal play is selected, the operating conditions, and the disc settings, you may not be able to select certain indications or the indications may appear differently.
- During playback, the SP/LP mode appears momentarily, and is then replaced by the elapsed time of the current track.



If you want to check the remaining time or the recording position while recording or in stop mode, see "Viewing various information" (page 29).

For the recorder operation, see page 59.

Selecting the play mode

You can select from the various play modes using the P-MODE/◀ button.

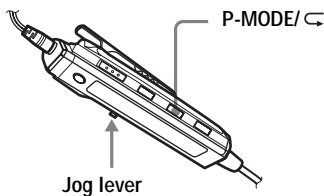



- 1 Press P-MODE/◀ repeatedly. Each time you press the button, the play mode changes as follows:

Display window on the remote control

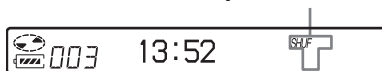
Play mode indication





Indication ¹⁾	Play mode
(none) (normal play)	All the tracks are played once.
1 (single-track play)	A single track is played once.
 (bookmark play)	Bookmarked tracks play back in order of their track number.
SHUF (shuffle play)	All the tracks are played in random order.

¹⁾ Group play mode () appears whenever you play a disc with group settings. For more details, see “Selecting the play mode for group play (Group Play Mode)” (page 47).

For the recorder operation, see page 56.

Playing a track repeatedly (Repeat Play)

You can use the repeat function for normal play, single-play, and shuffle play mode.

- 1 During playback in the selected play mode, press and hold P-MODE/ for 2 seconds or more.
 appears in the display.

To cancel repeat play

Press and hold P-MODE/ for 2 seconds or more.



By pressing P-MODE/ button during repeat play, you can change the play mode to be used with repeat play.

For the recorder operation, see page 56.

Listening to selected tracks only (Bookmark Play)

You can bookmark tracks on a disc and play them only. The sequence of bookmarked tracks cannot be changed.

To bookmark the tracks

- 1 While playing the track you want to bookmark, press and hold the jog lever for 2 seconds or more.

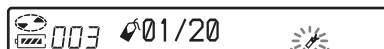



Flashing slowly

The first track of the bookmark play is set.

- 2 Repeat step 1 to bookmark other tracks.
You can bookmark up to 20 tracks.

To play the bookmarked tracks

- 1 During playback, press P-MODE/ repeatedly until “ TrPLAY?” appears in the display.
- 2 Press the jog lever.
The Bookmarked tracks start playing, starting with the smallest track number.

To erase a bookmark

While playing the track for which you want to erase the bookmark, press and hold the jog lever until “ OFF” appears.

Note

If you open the lid, all bookmarks are canceled.

For the recorder operation, see page 57.

Adjusting treble or bass (Digital Sound Preset)

You can adjust the treble and bass to suit your taste. The player can store two sets of treble-bass adjustments, which can then be selected later during playback.

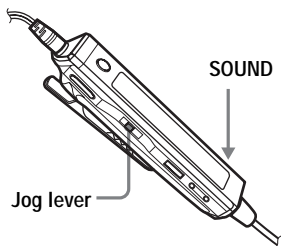

Selecting the sound quality

Factory settings

Factory settings of the Digital Sound Preset are as follows:

- "SOUND1": bass +1, treble ± 0
- "SOUND2": bass +3, treble ± 0

- 1 Press SOUND repeatedly to select "SOUND1" or "SOUND2" in the display.

To cancel Digital Sound Preset Select "OFF" in step 1.

Adjusting the sound quality

You can change the preset sound quality and store the results in "SOUND1" or "SOUND2".

- 1 Press SOUND repeatedly to select "SOUND1" or "SOUND2".

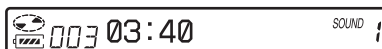

- 2 During playback, press SOUND for 2 seconds or more.

The recorder changes to B (bass) setting mode. Pressing jog lever changes the recorder to T (treble) setting mode.

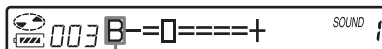

When you select bass-setting mode, "B" appears. When you select treble setting mode, "T" appears.

- 3 Slide the jog lever repeatedly to adjust the level.

Example: While adjusting the bass

The cursor moves.
(Position: -2)

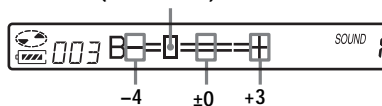

The sound can be adjusted in 8 steps (-4, -3, ..., ± 0 , ..., +2, +3).

To switch "B" (bass) and "T" (treble):

Press the jog lever.

To switch "SOUND1" and "SOUND2":

Press SOUND.

- 4 Press the jog lever to enter.
The sound settings are saved and the playback display appears again.

To cancel the setting

Press SOUND repeatedly until nothing appears in the display in step 1.

To cancel the procedure

Press and hold the DISPLAY button or  button for 2 seconds or more.

For the recorder operation, see page 58.



- Settings can also be changed while playback is momentarily paused (||).
- If the recorder is not operated approximately for 3 minutes, the current setting is stored and the display automatically switches to normal playback.

Notes

- When you use the Digital Sound Preset, the sound may break or become distorted depending on the settings or the track. In this case, change the settings of the sound quality.
- Changing to another Digital Sound Preset during a recording operation will not affect the quality of recorded sound.

This section explains the operations that are done on the recorder. For details on operations done on the remote control, see the pages indicated for each operation.

Before editing

You can edit your recordings by adding/erasing track marks or labeling tracks and MDs.

Notes

- Mastered MDs cannot be edited.
- Close the record-protect tab on the side of the MD before editing.
- The recorder is recording editing results while “TOC Edit” is flashing in the display.
 - Do not move or jog the recorder.
 - Do not disconnect the power source.
 - The lid does not open.

Labeling recordings (Name)

You can name tracks and discs using the recorder’s character palette.

Note

When you label a group, see page 50.

Available characters

- Capital and small letters of the English alphabet
- Numbers 0 to 9
- ! " # \$ % & () * . : ; < = > ?
@ _ ` + - ' , / : _ (space)

Maximum number of characters per name

Track names, group names, and disc name: Approx. 200 each (containing a mixture of all available characters)

Maximum number of characters that can be input per disc

Alphanumeric characters and symbols only: Approx. 120 titles of about 10 characters each (a maximum of about 1,700 characters)

The number of titles that can be stored on a disc depends on the number of characters that are input for track names, group names, and disc name.

Note

If you enter the symbol “//” between the characters in disc names such as “abc//def”, you may be unable to use the group function.

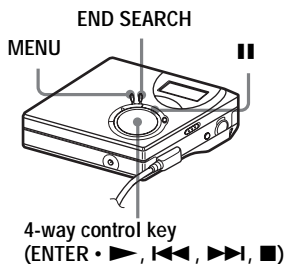

Labeling

You can label a track and a disc while the recorder is stopped, recording, or playing. Note that if you label a track while the recorder is stopped, the track must be the currently selected.

For labeling a group, see “Labeling recorded groups” (page 50).

- 1 Press MENU.
- 2 Press **◀◀** or **▶▶** repeatedly until “EDIT” appears in the display, and then press ENTER.
- 3 Press **◀◀** or **▶▶** repeatedly until “Name” appears in the display, and then press ENTER.

- 4 Press **◀◀** or **▶▶** repeatedly until the following item appears in the display, and then press ENTER.

When labeling a track	“T : Name”
When labeling a disc	“D : Name”

The cursor flashes in the letter input area and the track, group, or disc is ready to be labeled.



The cursor flashes.

- 5 Press **VOL +** or **-** to select a letter and press ENTER.

The selected letter appears and the cursor moves to the next input position.

The buttons used for character input and their functions are listed below.

Functions	Operations
To select a character	Press VOL + or - .
To enter a letter	Press ENTER .
To enter a name	Press ENTER for 2 seconds or more.
To insert a blank space before the cursor	Press END SEARCH and press VOL + at the same time.
To delete a letter	Press END SEARCH and press VOL - at the same time.
To switch capital and small letters.	Press II .
To cancel labeling.	Press ■ or MENU .

- 6 Repeat step 5, and then enter all characters of the label name.

- 7 Press **ENTER** for 2 seconds or more. A track or disc is labeled.

To return the preceding settings

Press **■**.

To cancel labeling

Press **■** for 2 seconds or more.

Note

When the recording is stopped while labeling a track or a disc during recording, or when the recording moves on to the next track while labeling a track, the input at that point is entered automatically.

Re-labeling recordings

Follow the procedure of the “Labeling” (page 40) to relabel a name.

Note

The recorder cannot rewrite a disc or track name of more than 200 letters that was created by another device.

For the remote control operation, see page 60.

Moving recorded tracks (Move)

You can change the order of the recorded tracks.

Note

To move tracks in a disc with group settings, see page 50.

Example

Move track C (track number 3) from the third to the second track.

Before moving

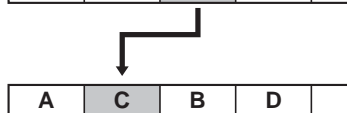

After moving

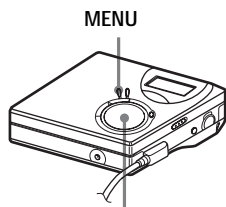

4-way control key
(ENTER • ►, ◀, ▶, ■)

- 1 While playing the track you want to move, press MENU.
- 2 Press ◀ or ▶ repeatedly until "EDIT" appears in the display, and then press ENTER.
The recorder plays the selected track repeatedly.
- 3 Press ◀ or ▶ repeatedly until "Move" appears in the display, and then press ENTER.

- 4 Press ◀ or ▶ repeatedly until "T : Move" appears in the display, and then press ENTER.

For example above, "→Tr003" appears in the display.

- 5 Press ◀ or ▶ repeatedly to select the destination track number.

- 6 Press ENTER.

The track moves to the selected destination track.

For example above, "002" appears in the display.

To return the preceding settings

Press ■.

To cancel moving

Press ■ for 2 seconds or more.

For the remote control operation, see page 60.

Dividing a track (Divide)

You can divide a track with a track mark, creating a new track from the part following the track mark. The track numbers will increase as follows.

Note

You cannot add a track mark on a track that has been checked-out from your computer.

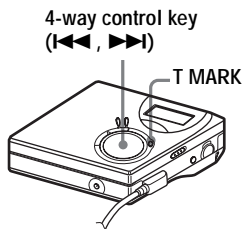
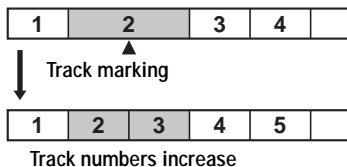

Dividing a track directly

- 1 While playing or pausing an MD, press T MARK on the recorder at the point you want to mark. “MK ON” appears in the display, and a track mark is added. The track number will increase by one.

To add track marks while recording (except while synchro-recording)

Press T MARK on the recorder at the point you want to add a track mark. You can use Auto Time Mark to add track marks automatically at specified intervals (except while digital recording) (page 34).

Combining tracks (Combine)

When you record with analog (line) input, unnecessary track marks may be recorded where recording level is low. You can erase a track mark to combine the tracks before and after the track mark.

Notes

- You cannot erase a track mark on a track that has been checked-out from your computer.
- To combine groups or tracks in a disc with group settings, see page 48.
- You cannot combine tracks recorded in different recording mode.

The track numbers will change as follows:

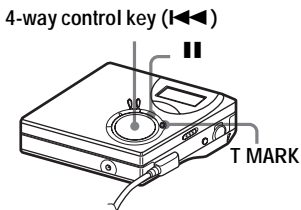
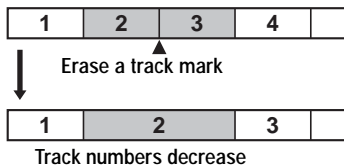

- 1 While playing the track with the track mark you want to erase, press || to pause.

- 2 Find the track mark by pressing ◀◀.

For example, to erase the third track mark, find the beginning of the third track. “00:00” appears in the display. “MK” appears in the display for a few seconds.

continued

- 3 Press T MARK to erase the mark.
“MK OFF” appears in the display.
The track mark is erased and the two tracks are combined.



When you erase a track mark, the date, time, and name assigned to the mark are also erased.

Note

When you erase a track mark between the two consecutive tracks that are assigned into different groups, the second track is re-assigned into the group containing the first track. In addition, if you combine a track that is assigned to a group with a track that is not assigned to a group (two consecutive tracks), the second track takes the same group assignment as the first track.

Erasing tracks and a whole disc contents (Erase)

You can erase unnecessary tracks or all tracks on a disc.

Notes

- You cannot erase tracks that have been checked out from your computer. You cannot erase an entire disc if it contains a checked-out track. In this case, check in the track or tracks to the computer.
- When you erase groups, see page 52.

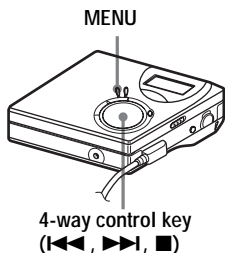

To erase a track

Note that once a recording has been erased, you cannot retrieve it. Make sure of the track you are erasing.

- 1 While playing the track you want to erase, press MENU.
- 2 Press ◀◀ or ▶▶ repeatedly until “EDIT” appears in the display, and then press ENTER.
- 3 Press ◀◀ or ▶▶ repeatedly until “Erase” appears in the display, and then press ENTER.
- 4 Press ◀◀ or ▶▶ repeatedly until “T : Ers” appears in the display, and then press ENTER.
“Erase?” and “ENTER” appear alternately in the display.
- 5 Press ENTER.
The track is erased and the next track starts to play. All the tracks after the one erased are automatically renumbered.

To erase a part of a track

Add track marks at the beginning and the end of the part you want to erase, then erase the part (page 42).

To return the preceding settings

Press ■.

To cancel erasing

Press ■ for 2 seconds or more.

For the remote control operation, see page 61.

To erase the whole disc

You can quickly erase all the tracks and data of the MD at the same time.

Note that once a recording has been erased, you cannot retrieve it. Be sure to check the contents of the disc before you erase it.

- 1 Play the disc you want to erase to check the contents.
- 2 Press ■ to stop.
- 3 Press MENU.
- 4 Press ◀◀ or ▶▶ repeatedly until “EDIT” appears in the display, and then press ENTER.
- 5 Press ◀◀ or ▶▶ repeatedly until “Erase” appears in the display, and then press ENTER.
- 6 Press ◀◀ or ▶▶ repeatedly until “D : Ers” appears in the display, and then press ENTER.
“Erase?” and “ENTER” appear alternately in the display.
- 7 Press ENTER.
“EDIT” appears in the display, and all the tracks will be erased.
When erasing is complete, “BLANK” appears in the display.

To return the preceding settings

Press ■.

To cancel moving

Press ■ for 2 seconds or more.

For the remote control operation, see page 61.

What is the group function?

The group function is provided to allow playback of discs with group settings. The group function is convenient for playback of MDs on which several albums or CD singles have been recorded in MDLP (LP2/LP4) mode.

What is a disc with group settings?

The recorder can operate various functions in units of group; that is tracks that have been recorded on a disc as a part of separate groups, as shown below.

Before group settings are made (normal play)

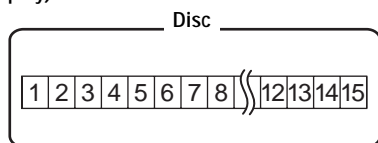

- Track 1 to 5 are assigned to group 1.
- Track 8 to 12 are assigned to group 2.
- Track 13 to 15 are assigned to group 3.
- Track 6 to 7 are not assigned to a group.

After setting the group (group play)

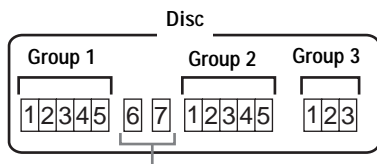

Tracks that were not assigned to a group are treated as being part of "Group - -".

You can create a maximum of 99 groups on a disc.

Note

It will not be possible to make a group setting if the tracks, groups and disc name on a disc exceed the maximum number that can be input.

Recording tracks using the group function

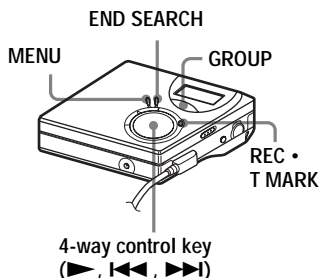

Recording a track to a new group

During recording, you can add a new group at the end of the currently recorded tracks on a disc.

- 1 While the recorder is stopped, press END SEARCH.
- 2 While pressing GROUP, press REC • T MARK and ▶.
- 3 Play the source sound.
A new group will be added after the current contents on a disc.

To stop recording

Press ■.

The material that was recorded up until ■ was pressed is entered as a new group.

Recording a track to an existing group

You can add a track to an existing group.

- 1 Press GROUP, and then press ◀◀ or ▶▶ until the group you want to add a track to appears in the display.
- 2 Press ▶ while pressing REC • T MARK.
- 3 Play the source sound.
Newly recorded track is added after the current contents in the group.



- To add a track that is currently playing to a group, stop or pause playing the track first, and then do the procedure from step 2.
- You can set the recorder to always create a new group without pressing the GROUP button. See page 56 for details.

Playing groups

The recorder can operate various playback with a disc which has group setting.

This section explains the operations that are done on the remote control. For details on operations on the recorder, see page 57

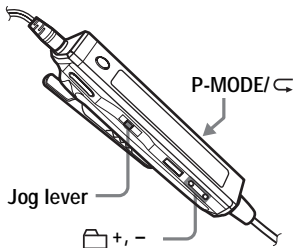

Playing a track in group play

In group play, all groups are played in order, starting with group 1, followed by the unassigned tracks (“Group - -”). Playback stops after all the tracks have been played.

- 1 During playback, press P-MODE/⏏ repeatedly until “⏏” appears in the display.

To cue to the start of a group (Group Skip)

- 1 During playback, press ⏏ + or -. Pressing ⏏ - button cues to the first track in the current group. Pressing the button again cues to the first track of the previous group.

For the recorder operation, see page 57.

Selecting the play mode for group play (Group Play Mode)

The shuffle play and repeat play function can be used during group play mode.

- 1 Press P-MODE/⏏ repeatedly.
After normal playback (page 36), the following play modes are displayed.

Display	Play mode
⏏ (Normal Group Play)	All tracks in the groups play back once (starting with the first track in group 1).
⏏, SHUF (In-Group Shuffle)	Shuffle play starts with the group that is currently playing, and continues with the succeeding groups.

Repeat play for the selected group play mode (Group Repeat Play)

- 1 During playback in the selected group mode, press and hold P-MODE/ \square for 2 seconds or more.
“ \square ” appears in the display.
Playback repeats in the respective group play mode.

Display	Play mode
\square \square	Repeat play of tracks within a group
\square SHUF \square	Repeat shuffle play of tracks within a group

Editing groups

This section explains the operations that are done on the recorder.

Assigning tracks or groups as a new group (Group Setting)

With this function, you can assign existing tracks or groups to a new group, and also you can assign a track that currently belongs to no group to an existing group.

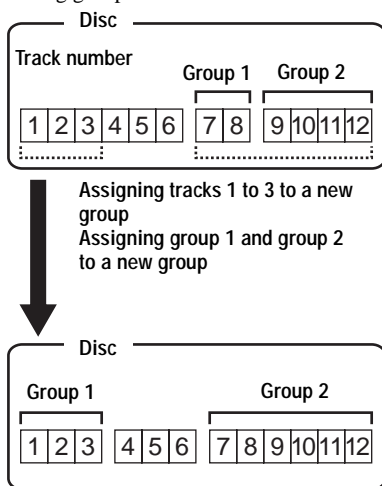

Group assignment of non-consecutive tracks is not possible (for example, track 3 and tracks 7 to 8 cannot be assigned to a new group).

Track numbers appear according to their order on the disc, not their order within the group.

Notes

- You can create a maximum of 99 groups on a disc. It will not be possible to make a group setting if the tracks, groups and disc name on a disc contain more than the maximum number of characters that can be stored.
- The tracks or groups must be sequential. If the desired tracks or groups are not consecutive, you must move them to make them consecutive before you can assign them (“Moving recorded tracks (Move)”, page 42).

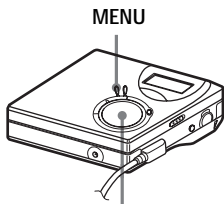

4-way control key
(ENTER • ►►, ◀◀, ►►, ■)

- 1 While the recorder is stopped, press MENU.
- 2 Press ◀◀ or ►► until “EDIT” appears in the display, and then press ENTER.
- 3 Press ◀◀ or ►► until “G : Set” appears in the display, and then press ENTER.
The track number of the first track (“STR”) appears in the display.



- 4 Press ◀◀ or ►► until the number of the desired first track appears in the display, and then press ENTER.
This selects the first track of the new group.

- 5 Press ◀◀ or ►► until the number of the desired last track appears in the display, and then press ENTER.
This selects the last track of the new group.
- 6 Label a group (see “Labeling recorded groups” (page 50)).

To return the preceding settings

Press ■.

To cancel the operation

Press ■ for 2 seconds or more.

Notes

- In step 4, the first track must be either the first track of an existing group or a track that does not belong to a group.
- When selecting the last track in step 5, make sure the track comes after the one selected in step 4. The last track must be either the last track of an existing group or a track that does not belong to a group.

For the remote control operation, see page 62.

Releasing a group setting

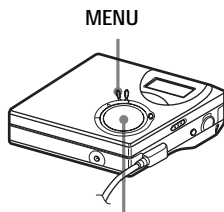

4-way control key
(◀◀, ►►, ■)

- 1 Select a group you want to release and check the contents (see “Playing a track in group play” (page 47)).
- 2 Press ■.

continued

- 3 Press MENU.
- 4 Press **⏮** or **⏭** until "EDIT" appears in the display, and then press ENTER.
- 5 Press **⏮** or **⏭** until "G : Rls" appears in the display, and press ENTER.
"G : Rls?" and "ENTER" appear alternately in the display.
- 6 Press ENTER.
The group setting of the selected group is released.

To return the preceding settings

Press **■**.

To cancel the operation

Press **■** for 2 seconds or more.

For the remote control operation, see page 62.

Labeling recorded groups

You can label a group while the recorder is recording or playing a track in the group. You can also label a group while a track in the group is selected and the recorder is stopped.

- 1 Do the procedure of "Labeling" (page 40) and select "G : Name" in step 4, and then do steps 5 to 7.

For the remote control operation, see page 60.

Moving a track in a disc with group setting

You can move a track from one group out of the group or to another group. You can also move a track that is not belong to a group into an existing group.

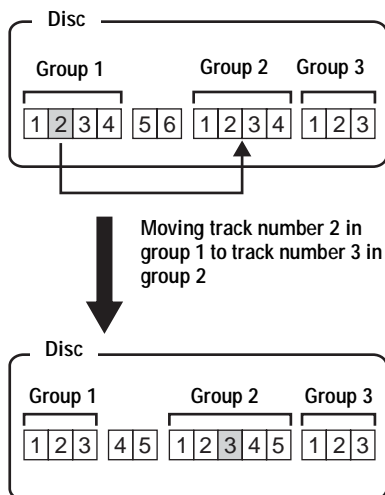

MENU

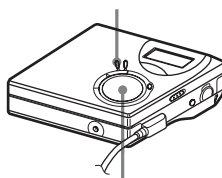

4-way control key
(**⏮**, **⏭**, **■**)

- 1 While playing the track you want to move, press MENU.
- 2 Press **⏮** or **⏭** until "EDIT" appears in the display, and then press ENTER.

- 3 Press **◀◀** or **▶▶** until “Move” appears in the display, and then press ENTER.
- 4 Press **◀◀** or **▶▶** until “T : Move” appears in the display, and then press ENTER.



- 5 When moving a track out of a group, skip this step. When moving a track into a different group, press **◀◀** or **▶▶** until the destination group appears in the display, and then press ENTER.

The indications will appear alternately as follows, for example.



The destination group



The number of the track within the destination group

- 6 Press **◀◀** or **▶▶** until the number of the destination track (within a group when moving into a different group) appears in the display, and then press ENTER.
The selected track number appears in the display.

To return the preceding settings

Press **■**.

To cancel moving

Press **■** for 2 seconds or more.

For the remote control operation, see page 60.

Changing the order of a group on a disc (Group Move)

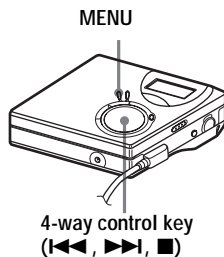

- 1 While playing a track within a group whose order you want to change, press MENU.
- 2 Press **◀◀** or **▶▶** until “EDIT” appears in the display, and then press ENTER.
- 3 Press **◀◀** or **▶▶** until “Move” appears in the display, and then press ENTER.
- 4 Press **◀◀** or **▶▶** until “G : Move” appears in the display, and then press ENTER.

continued

- 5 Press **◀◀** or **▶▶** to select the destination point on the disc, and then press **ENTER**.

To return the preceding settings

Press **■**.

To cancel moving

Press **■** for 2 seconds or more.

For the remote control operation, see page 61.

To erase a group

You can erase tracks in a selected group.

Note that once a recording has been erased, you cannot retrieve it. Be sure to check the contents of the group before you erase it.

Note

You cannot erase tracks that have been checked out from your computer. You cannot erase a group if it contains a checked-out track. In this case, check in the track or tracks to the computer.

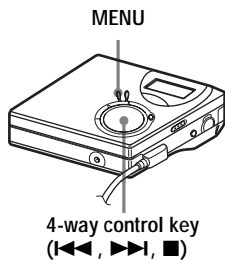

- 1 Select a group you want to erase and check the contents (see “To cue to the start of a group (Group Skip)” (page 47)).
- 2 Press **■**.
- 3 Press **MENU**.

- 4 Press **◀◀** or **▶▶** until “EDIT” appears in the display, and then press **ENTER**.

- 5 Press **◀◀** or **▶▶** until “Erase” appears in the display, and then press **ENTER**.

- 6 Press **◀◀** or **▶▶** until “G : Ers” appears in the display, and then press **ENTER**.

The group name, “G : Ers?” and “ENTER” appear alternately in the display.

- 7 Press **ENTER**.

The group is erased.

To return the preceding settings

Press **■**.

To cancel erasing

Press **■** for 2 seconds or more.

For the remote control operation, see page 62.

Useful settings

The recorder has many menus with useful functions for recording, playback, editing, etc. The following table shows the menu items that you can select. Some items can be set with both the recorder and the remote control, and some can be set with either the recorder or the remote control.

Category	Function	What it does	Operation	Site page
General operations	Beep on/off	Turns the beep sound on or off.	recorder	page 56
			remote control	page 56
Recording	Synchro-Recording	Simplifies operations during digital recording.	recorder	page 30
	Long-time recording	Selects the recording mode (SP, LP2, LP4, or monaural).	recorder	page 31
	Adding track marks (Divide)	Adds track marks automatically at specified intervals.	recorder	page 33
	Adjusting the recording level	Manually adjusts the recording level.	recorder	page 34
	Selecting the record-starting point	Allows you to specify whether material is overwritten or not when recording.	recorder	page 56
	Group recording	Sets the recorder to create a new group with each recording operation.	recorder	page 56
Playing	Selecting the play mode	Selects the play mode, such as repeat play, shufful play, etc.	recorder	page 38
			remote control	page 36
	Changing the sound quality	Adjust the treble and bass, and stores two sets of treble-bass adjustment.	recorder	page 58
			remote control	page 38
	Starting playback quickly	Sets the recorder to start playback or cue to a track quickly.	recorder	page 58
			remote control	page 58
	Limiting the maximum volume	Sets a limit on the maximum volume to protect your hearing.	recorder	page 59
			remote control	page 59

Category	Function	What it does	Operation	Site page
Display	Viewing information	Displays various information such as the remaining time, etc. in the display window.	recorder	pages 29 and 36
			remote control	page 30 and page 59
Editing	Labeling (Name)	Labels tracks, groups, or the disc.	recorder	page 40 (track and disc) page 50 (group)
			remote control	page 60
	Moving	Changes the order of tracks or groups.	recorder	page 42 (track) page 50 (group)
			remote control	page 60
	Erasing	Erases tracks, groups, or the entire disc contents.	recorder	page 44 (track and disc) page 52 (group)
			remote control	page 61
	Assigning tracks to groups	Assigns recorded tracks or groups to a new group.	recorder	page 48
			remote control	page 62
	Releasing a group	Releases group settings.	recorder	page 49
			remote control	page 62

How to use the menu items

To set the menu items, do the following procedure.

On the recorder:

- 1 Press MENU to enter the menu.
- 2 Press ◀◀ or ▶▶ to select the item.
- 3 Press ENTER to enter the selection.
- 4 Repeat steps 2 and 3.
The setting will be entered when you press ENTER at the last.

To return the preceding setting

Press ■.

To cancel the operation while setting

Press and hold ■ for 2 seconds or more.

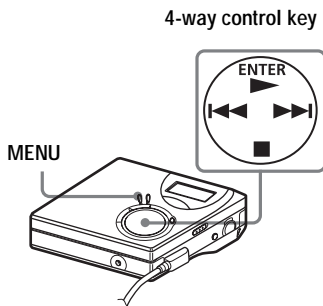

On the remote control:

- 1 Press and hold DISPLAY for 2 seconds or more to enter the menu
- 2 Slide the jog lever to select the item.
- 3 Press the jog lever to enter the selection.
- 4 Repeat steps 2 and 3.
The setting will be entered when you press the jog lever at the last.

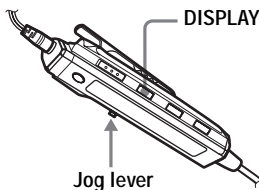

To return the preceding setting

Press ■.

To cancel the operation while setting

Press and hold ■ for 2 seconds or more.

Turning off the beep sound

You can turn on/off the beep sound on the recorder and the remote control.

- 1 Enter the menu and select "OPTION" - "BEEP".
- 2 Select "OFF".

To turn on the beep sound
Select "ON".

Recording without overwriting existing material

If you wish to avoid recording over the current contents of an MD, do the following procedure. All new material will then be recorded from the end of the current contents. The recorder is factory set to record over existing material.

- 1 Enter the menu and select "OPTION" - "R-Posi".
- 2 Select "Fr End".

To start recording over the current contents
Select "FrHere".



- To temporarily record without recording over the current contents, press END SEARCH before the start of recording. The recording will begin after the last track, even if "R-Posi" is set to "FrHere" (factory setting). The remaining recordable time on the disc will appear in the display when you press END SEARCH.
- If the group recording setting ("G-REC") is set to "G-ON", the recorder will always set to "Fr End".

Creating a new group when recording

By pressing while pressing REC • T MARK, you can set the recorder to create a new group automatically each time you record. This is convenient when recording several CDs in succession.

- 1 While the recorder is stopped, enter the menu and select "R-SET" - "G-REC".
- 2 Select "G-ON".

To turn the setting to normal
Select "G-OFF".

Selecting the play mode

For details and remote control operation, see page 36.

- 1 While the recorder is playing, enter the menu and select "P-MODE".
- 2 Select the desired play mode.



When you press , **B** changes.
When you press ENTER, **A** appears.

Indication A / B 1)	Play mode
Normal/—	All the tracks are played once.
1 Trk/1	A single track is played once.

Indication A/ B 1)	Play mode
	Bookmarked tracks play back in order of their track number.
Shuff/SHUF	All the tracks are played in random order

¹⁾ Group play mode () appears whenever you play a disc with group settings. For more details, see “Selecting the play mode for group play (Group Play Mode)” (page 47).

- 3 Select “RepON” (playing a track repeatedly) or “RepOFF”.
When you select “RepON”, “ ” appears on **A** and the playback repeats with the play mode selected in step 2.

Listening to selected tracks only (Bookmark Play)

To bookmark the tracks

- 1 While playing the track you want to bookmark, press and hold  for 2 seconds or more.

Flashing slowly

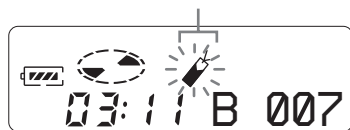

The first track of the bookmark play is set.

- 2 Repeat step 1 to bookmark other tracks.
You can bookmark up to 20 tracks.

To play the bookmarked tracks

- 1 Select “ TrPLAY?” appears in the display in step 2 of “Selecting the play mode” (page 56).
- 2 Select “RepON” or “RepOFF”.

To erase bookmarks

While playing the track for which you want to erase the bookmark, press  for 2 seconds or more.





Note

If you open the lid, all bookmarks are canceled.

Playing a track in group play

- 1 Do steps 1 and 2 of (“Selecting the play mode”, page 56) and select “ Normal” in step 2.



To cue to the start of a group (Group Skip)

- 1 Press GROUP.
- 2 While “ ” flashing, press  or .
Pressing  button cues to the first track in the current group. Pressing the  button again cues to the first track of the previous group.

For the remote control operation, see page 47.

Selecting the play mode for group play (Group Play Mode)

- 1 Do steps 1 to 2 of “Selecting the play mode” (page 56).
The following group play mode appears after normal play modes.

Display	Play mode
 (Normal Group Play)	All tracks in the groups play back once (starting with the first track in group 1.)
 , SHUF (In-Group Shuffle)	Shuffle play starts with the group that is currently playing, and continues with the succeeding groups.

- 2 Select “RepON” or “RepOFF”.

Adjusting treble or bass (Digital Sound Preset)

For details and remote control operation,
see page 38.

Selecting the sound quality

- 1 Enter the menu and select "SOUND"
- "SOUND1" or "SOUND2".

To cancel Digital Sound Preset
Select "OFF".

Adjusting the sound quality

- 1 Enter the menu and select "SOUND"
- "SET".
- 2 Press ◀◀ or ▶▶ repeatedly to
select "SOUND1" or "SOUND2",
and then press ENTER.

The display shows the currently
selected "BASS" sound setting.

- 3 Press ◀◀ or ▶▶ repeatedly to
adjust the sound level.

Shows "SOUND1" or "SOUND2" is
selected



The sound can be adjusted in 8 steps
(-4, -3, ..., ±0, ..., +2, +3).

- 4 Press ENTER.
"BASS" is set and the display
changes to "TRE" (treble) setting
mode.

- 5 Press ◀◀ or ▶▶ repeatedly to
adjust the sound level, and then press
ENTER.

"TRE" (treble) is set.

The sound settings are saved and the
playback display appears again.

To cancel selecting

Press CANCEL.

Starting the playback quickly (Quick Mode)

After pressing the playback button or
cueing to the track, the playback can start
quickly.

- 1 Enter the menu and select "OPTION"
- "Power".
- 2 Select "QUICK".

Display window on the recorder



Display window on the remote control



To switch back to the normal
setting

Select "NORMAL" in step 2.

Notes

- When the power mode is set to “QUICK”, the power remains on within the recorder even when nothing appears in the display. This leads to a shorter battery life. For this reason, it is recommended that you charge the battery daily.
- If no recorder operation (including opening or closing of the lid) occurs for an hour, the power in the recorder automatically turn off. For this reason, the next time you start playback or do another operation, the recorder will not respond quickly. The unit, however, will return to quick mode afterwards.

Protecting your hearing (AVLS)

The AVLS (Automatic Volume Limiter System) function keeps down the maximum volume to protect your ears.

- 1 Enter the menu and select “OPTION” - “AVLS”.
- 2 Select “ON”.
When you try to turn the volume too high, “AVLS” appears in the display. The volume is kept to a moderate level.

To cancel the AVLS
Select “OFF” in step 2.

Viewing various information

- 1 While playing, enter the menu and select “DISP”.
- 2 Select the information you want.
Each time you press ◀◀ or ▶▶, the display changes as the follows:



Indication: **A/B**

B (Selected item)	A	B (After a few seconds)
LapTim	Elapsed time	Track number
I Rem	Remaining time of the current track	Track name
GP Rem	Remaining time after the current track in a group	Group name
AllRem	Remaining time after the current location	Disc name

Note

Depending on whether group play or normal play is selected, the operating conditions, and the disc settings, you may not be able to select certain indications or the indications may appear different.

For the details and the remote control operation, see page 29.

Labeling (Name)

- 1 Enter the menu and select “EDIT” - “Name”
- 2 Select one of the following:

When labeling a track	“🎵 : Name”
When labeling a disc	“🌀 : Name”

The cursor appears in the display and the track, group, or disc is ready to be labeled.

- 3 Press VOL + or – repeatedly to select a letter and press the jog lever.
The selected letter stops flashing and the cursor moves to the next input position.

The cursor flashes at the next input position.

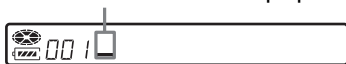

Functions	Operation
To move the cursor to the left or right	Slide the jog lever (◀, ▶)
To change the letter to the one before/next one	Press VOL +, -.
To enter a letter	Press the jog lever (▶ /ENT).
To enter a name	Press the jog lever for 2 seconds or more (▶ /ENT).
To switch between capital letters, small letters, and numbers/marks	Press P-MODE/☐.
To insert a blank space	Press ☐ +.
To delete a letter	Press ☐ -.
To cancel labeling	Press ■ for 2 seconds or more.

- 4 Repeat step 3 and enter all characters of the label name.
- 5 Press and hold the jog lever for 2 seconds or more.

For the details and the recorder operation, see page 40.

Labeling recorded groups

- 1 Select “☐ : Name” in step 2 of “Labeling (Name)” (page 60) and do steps 3 to 5 to label a group.

For the details and the recorder operation, see page 50.

Re-labeling recordings

You can relabel recordings by following the procedure of “Labeling (Name)” (page 60).

For the details and the recorder operation, see page 41.

Moving recorded tracks

- 1 While playing the track you want to move, enter the menu and select “EDIT” - “Move” - “🎵 : Move”.
For example, “003 → Tr003” appears in the display.



- 2 Slide the jog lever repeatedly until the destination track number appears in the display.
For example, “003 → Tr002” appears in the display.



- 3 Press the jog lever to enter the selection.

For details and the recorder operation, see page 42.

Moving a track in a disc with group setting

- 1 While playing the track you want to move enter the menu and select “EDIT” - “Move” - “🎵 : Move”.
- 2 When moving a track out of a group, skip this step.
When moving a track into a different group, slide the jog lever until the destination group appears in the display, and then press the jog lever.



- 3 Slide the jog lever repeatedly until the number of the destination track (within a group when moving into a different group) appears in the display, and then press the jog lever to enter the selection.

For details and the recorder operation, see page 50.

Changing the order of a group on a disc (Group Move)

- 1 While playing the track you want to move enter the menu and select “EDIT” - “Move” - “📁 Move”.
- 2 Slide the jog lever repeatedly to select a destination point on the disc, and then press the jog lever to enter the selection.

Example: When moving the first group (GP01) to the second group (GP02)

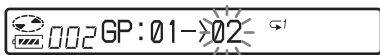

For details and the recorder operation, see page 51.

Erasing tracks, the entire disc or groups (Erase)

Erasing tracks

- 1 While playing the track you want to erase, enter the menu and select “EDIT” - “Erase” - “🎵 : Erase”.
“Erase OK?” and “PushENTER” appear alternately in the display.
- 2 Press the jog lever to erase a track.

For details and the recorder operation, see page 44.

To erase the whole disc

- 1 Play the disc you want to erase to check the contents.
- 2 Press ■ to stop.
- 3 Enter the menu and select “EDIT” - “Erase” - “📀 : Erase”.
“AllErase?” and “PushENTER” appear alternately in the display.
- 4 Press the jog lever to erase the whole disc.

For details and the recorder operation, see page 45.

To erase a group

- 1 Select a group you want to erase and check the contents (see “To cue to the start of a group (Group Skip)” (page 47)).
- 2 Press ■ to stop.
- 3 Enter the menu and select “EDIT” - “Erase” - “ : Erase”. “GP Erase?” and “PushENTER” appear alternately in the display.
- 4 Press the jog lever to enter the selection.

For details and the recorder operation, see page 52.

Assigning tracks or groups as a new group (Group Setting)

- 1 Enter the menu and select “EDIT” - “ : Set”.
- 2 Slide the jog lever repeatedly until the number of the desired first track appears in the display, and then press the jog lever.

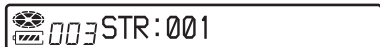

- 3 Slide the jog lever repeatedly until the number of the desired last track appears in the display, and then press the jog lever.
- 4 Label a group (see “Labeling recorded groups” (page 50)).

For details and the recorder operation, see page 48.

Releasing a group setting

- 1 Select a group that you want to release and check the contents (see “To cue to the start of a group (Group Skip)” (page 47)).
- 2 Press ■.
- 3 Enter the menu and select - “EDIT” - “ : Release”. “Release?” and “PushENTER” appear alternately in the display.
- 4 Press the jog lever to enter the selection.

For details and the recorder operation, see page 49.



List of menus

Menus on the recorder

Items listed under “Menu 1” are the selectable items which appear when you press MENU, items listed under “Menu 2” are the selectable items which appear when you select an item in Menu 1, and “Menu 3” are the selectable items which appear when you select an item in Menu 2.











Note

Different indication may be displayed depending on the operating conditions and settings.

Menu 1	Menu 2	Menu 3
EDIT	Name	T : Name ↔ G : Name ↔ D : Name
	G : Set	—
	G : Rls	—
	Move	T : Move ↔ G : Move
	Erase	T : Ers ↔ G : Ers ↔ D : Ers
DISP	LapTim	—
	RecRem (while recording and stopped)/1 Rem (while playing)	—
	GP Rem	—
	AllRem	—
P-MODE	Normal	RepOFF (factory setting) ↔ RepON
	1 Trk	
	 TrPLAY	
	Shuff	
	 Normal	
	 Shuff	
SOUND	OFF	—
	SOUND1	—
	SOUND2	—
	SET	SOUND1 ↔ SOUND2

Menu 1	Menu 2	Menu 3
R-SET	R-MODE	SP (factory setting) ↔ LP2 ↔ LP4 ↔ MONO
	RecVol	Auto (factory setting) ↔ Manual
	TimeMk	MK OFF (factory setting) ↔ MK ON
	G-REC	G-OFF (factory setting) ↔ G-ON
	SYNC-R	OFF (factory setting) ↔ ON
OPTION	AVLS	OFF (factory setting) ↔ ON
	BEEP	OFF ↔ ON (factory setting)
	R-Posi	FrHere (factory setting) ↔ Fr End
	Power	NORMAL (factory setting) ↔ QUICK

On the remote control

Menu 1	Menu 2	Functions
EDIT	Name	 : Name ↔  : Name ↔  : Name
	 : Set	—
	 : Release	—
	Move	 : Move ↔  : Move
	Erase	 : Erase ↔  : Erase ↔  : Erase
OPTION	AVLS	AVLS OFF (factory setting) ↔ AVLS ON
	BEEP	BEEP OFF ↔ BEEP ON (factory setting)
	PowerMode	NORMAL (factory setting) ↔ QUICK

Presetting radio stations automatically

You can automatically preset radio stations whose reception is good. Once a station is preset, you can tune it in at any time simply by selecting the preset number. Up to 40 stations can be preset, 30 for FM and 10 for AM. (If your unit is the USA model, you can preset 51 stations, 30 for FM, 10 for AM, 7 for TV and 4 for weather.)

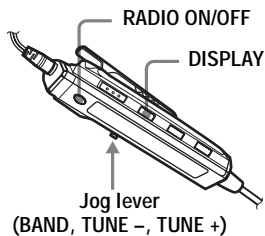

- 1 Press RADIO ON/OFF to turn on the radio.
- 2 Press the jog lever repeatedly to select the band.
USA model: "FM" → "AM" → "TV"
→ "Wb (weather)"
Canadian model: "FM" → "AM"
- 3 Press and hold DISPLAY until "A Preset" appears in the display.
- 4 Press the jog lever.
Scanning starts.

PRESET
FM **A** 87.50MHz

The station frequencies are stored in memory in order of low to high, starting with preset number 1. When storing finishes, "A" stops flashing.

Presetting radio manually

If the automatic presetting function fails to find the station that you want because of poor reception, do the steps below to manually store the radio station to a preset number.

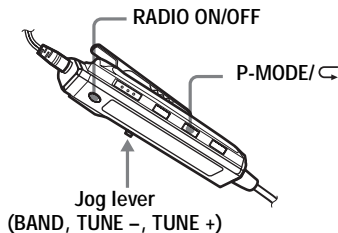

- 1 Press RADIO ON/OFF to turn on the radio.
If "PRESET" is displayed, press P-MODE/ \square to make it disappear from the display.
- 2 Press the jog lever repeatedly to select the band.
USA model: "FM" → "AM" → "TV"
→ "Wb (weather)"
Canadian model: "FM" → "AM"
- 3 Slide the jog lever towards TUNE + or TUNE - repeatedly to tune the desired radio station.
- 4 Press and hold the jog lever until "M" and the preset number flash in the display.
- 5 Slide the jog lever repeatedly until the desired preset number appears in the display.

PRESET
FM **M** 87.50MHz

- 6 Press the jog lever to enter the selection.
A long beep sounds in the headphones/earphones. “PRESET”, “M”, and preset number disappear in the display.

Listening to the preset radio stations

You can simply tune the station by selecting the preset number.

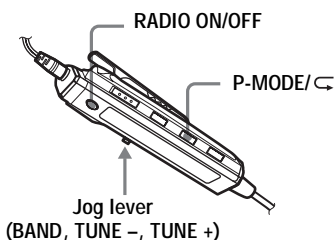

- 1 Press RADIO ON/OFF to turn on the radio.
- 2 Press the jog lever repeatedly to select the band.
USA model: “FM” → “AM” → “TV” → “Wb (weather)”
Canadian model: “FM” → “AM”
- 3 Press P-MODE/⏪ so that “PRESET” appears in the display.
- 4 Slide the jog lever towards TUNE + or TUNE - repeatedly until the desired preset number appears in the display.

Receiving stations in another country

The frequency step differs according to the geographical region. If you cannot tune in stations clearly while in another country, try changing the frequency step to match that of the particular region.

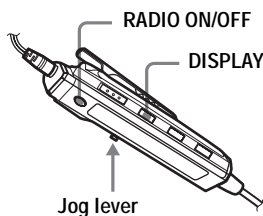

- 1 Press RADIO ON/OFF to turn on the radio.
- 2 Press and hold DISPLAY until “A Preset” appears in the display.
- 3 Slide the jog lever repeatedly until “Step” appears in the display, and then press the jog lever.
- 4 Slide the jog lever repeatedly until “Step10k” or “Step9k” appears in the display.

Step10K

The frequency interval for each step is as follows.

Band	Step 10k	Step9k
FM	100 kHz	50 kHz
AM	10 kHz	9 kHz

Note

After changing the frequency interval, you need to preset radio station.

- 5 Press the jog lever to enter the selection.

You can use the recorder on house current or as follows.

- a nickel metal hydride rechargeable battery NH-7WMAA
- an LR6 (size AA) alkaline dry battery

It is preferable to use the recorder on house current when recording for a long time. When using a battery, make sure it is a fully charged rechargeable battery or a new alkaline dry battery to prevent operations (e.g., recording and editing) from failing due to insufficient battery power.

Battery life

The battery life may be shorter due to operating conditions, the temperature of the location, or alkaline dry battery you use.

When recording

(Unit: approx.hours)(JEITA¹⁾)

Batteries	SP Stereo	LP2 Stereo	LP4 Stereo
Nickel metal hydride rechargeable battery ²⁾	5.5	8	9
LR6 Sony alkaline dry battery ³⁾	9	12	16

¹⁾ Measured in accordance with the JEITA (Japan Electronics and Information Technology Industries Association) standard.

²⁾ When using a 100% fully charged nickel metal hydride rechargeable battery (NH-7WMAA).

³⁾ When using a Sony LR6 (SG) "STAMINA" alkaline dry battery (produced in Japan).

When playing

(Unit: approx.hours)(JEITA)

Batteries	SP Stereo	LP2 Stereo	LP4 Stereo
Nickel metal hydride rechargeable battery	14.5	15.5	17.5
LR6 Sony alkaline dry battery	36	42.5	48

When using the radio

(Unit: approx.hours)(JEITA)

Batteries	FM/AM	TV/Wb (weather) (USA model only)
Nickel metal hydride rechargeable battery	7.5	7
LR6 Sony alkaline dry battery	18.5	17

Note

When you use the radio, it is recommended that you use a fully charged rechargeable battery or a new dry battery since more power is consumed by the radio than by MD playback.

When to replace the batteries

When the dry battery or rechargeable battery is weak, flashing  or "LOW BATT" appears in the display. Replace the dry battery or charge the rechargeable battery.

The battery level indicator is approximate. It may be more or less than the indication depending on the operating condition.

Note

Stop the recorder before replacing battery.

Precautions

On safety

Do not put any foreign objects in the DC IN 3V jack.

On power sources

- Use house current, nickel metal hydride rechargeable battery, LR6 (size AA) battery, or car battery.
- For use in your house: Do not use any other AC power adaptor since it may cause the recorder to malfunction.

Polarity of the plug



- Connect the AC power adaptor to an easily accessible AC outlet. Should you notice an abnormality in the AC power adaptor, disconnect it from the AC outlet immediately.
- The recorder is not disconnected from the AC power source (mains) as long as it is connected to the wall outlet, even if the recorder itself has been turned off.
- If you are not going to use this recorder for a long time, be sure to disconnect the power supply (AC power adaptor, dry battery, rechargeable battery, or car battery cord). To remove the AC power adaptor from the wall outlet, grasp the adaptor plug itself; never pull the cord.

On heat build-up

Heat may build up in the recorder if it is used for an extended period of time. This, however, is not a malfunction.

On installation

- Never use the recorder where it will be subjected to extremes of light, temperature, moisture or vibration.
- Never wrap the recorder in anything when it is being used with the AC power adaptor. Heat build-up in the recorder may cause malfunction or damage.

On the headphones/earphones

Road safety

Do not use headphones/earphones while driving, cycling, or operating any motorized vehicle. It may create a traffic hazard and is illegal in many areas. It can also be potentially dangerous to play your recorder at high volume while walking, especially at pedestrian crossings. You should exercise extreme caution or discontinue use in potentially hazardous situations.

Preventing hearing damage

Avoid using headphones/earphones at high volume. Hearing experts advise against continuous, loud and extended play. If you experience a ringing in your ears, reduce the volume or discontinue use.

Caring for others

Keep the volume at a moderate level. This will allow you to hear outside sounds and to be considerate of the people around you.

On the remote control

The supplied remote control is designated for this recorder only. You cannot use the recorder with a remote control supplied with other equipment.

Note on charging

- Be sure to use the supplied AC power adaptor.
- Charge the rechargeable battery at a temperature of +5°C (+41°F) to +40°C (+104°F).
- Though the battery and the recorder may become hot during the charging procedure, this poses no danger.
- If you are charging the battery for the first time or after a long period of disuse, the battery may not charge up to its rated capacity. This is a normal characteristic. After you use and recharge the battery a few times, it will return to its normal charge capacity.

On the MiniDisc cartridge

- When carrying or storing the MiniDisc, keep it in its case.
- Do not break open the shutter.
- Do not place the cartridge where it will be subject to light, extreme temperatures, moisture or dust.
- Attach the supplied MD label only in the space designated for it on the disc. Do not stick it on any other disc surface.

On cleaning

- Clean the recorder casing with a soft cloth slightly moistened with water or a mild detergent solution. Do not use any type of abrasive pad, scouring powder or solvent such as alcohol or benzene as it may mar the finish of the casing.
- Wipe the disc cartridge with a dry cloth to remove dirt.
- Dust on the lens may prevent the unit from operating properly. Be sure to close the disc compartment lid after inserting or ejecting an MD.
- To obtain the best sound quality, use a dry cloth to wipe the plugs of the headphones/earphones or the remote control. Dirty plugs may cause sound distortion or intermittent breaks in the sound.

Notes on batteries

Incorrect battery usage may lead to leakage of battery fluid or bursting battery. To prevent such accidents, observe the following precautions:

- Install the + and – poles of the battery correctly.
- Do not try to recharge dry battery.
- When the recorder is not to be used for a long time, be sure to remove the batteries.
- If a battery leak should develop, carefully and thoroughly wipe away battery fluid from the battery compartment before inserting new ones.

Note on mechanical noise

The recorder gives off mechanical noise while operating, which is caused by the power-saving system of the recorder and it is not a problem.

To protect a recorded MD

To record-protect an MD, slide open the tab at the side of the MD. In this position, the MD cannot be recorded. To record again, slide the tab back so the tab is visible.

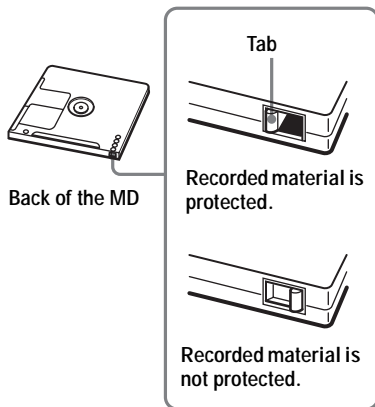

Note on maintenance

Clean the terminals periodically with a cotton swab or a soft cloth.

If you have any questions or problems concerning your recorder, please consult your nearest Sony dealer. (If a trouble occurred when the disc was in the recorder, we recommend that the disc be left in the recorder when you consult your Sony dealer so that the cause of trouble may be better understood.)

Specifications

MD recorder

Audio playing system

MiniDisc digital audio system

Laser diode properties

Material: GaAlAs

Wavelength: $\lambda = 790$ nm

Emission duration: continuous

Laser output: less than 44.6 μ W

(This output is the value measured at a distance of 200 mm from the lens surface on the optical pick-up block with 7 mm aperture.)

Recording and playback time (when using MDW-80)

Maximum 160 min. in monaural

Maximum 320 min. in LP4 stereo

Revolutions

380 rpm to 2,700 rpm (CLV)

Error correction

ACIRC (Advanced Cross Interleave Reed

Solomon Code)

Sampling frequency

44.1 kHz

Sampling rate converter

Input: 32 kHz/44.1 kHz/48 kHz

Coding

ATRAC (Adaptive TRansform Acoustic Coding)

ATRAC3 — LP2/LP4

Modulation system

EFM (Eight to Fourteen Modulation)

Frequency response

20 to 20,000 Hz \pm 3 dB

Inputs¹⁾

Line in:

stereo mini-jack for analog input

(minimum input level 49 mV)

optical (digital) mini-jack for optical

(digital) input

Outputs

: stereo mini-jack

Maximum output level

5 mW + 5 mW; load impedance 16 Ω

Radio

Frequency range

USA model:

FM: 87.5-108 MHz

AM: 530-1,710 kHz (10 kHz step)

531-1,710 kHz (9 kHz step)

TV: 2-13 CH

WEATHER: 1-7 CH

Canadian model:

FM: 87.5-108 MHz

AM: 530-1,710 kHz (10 kHz step)

531-1,710 kHz (9 kHz step)

Antenna

FM/TV/WEATHER:

Headphones/earphones cord antenna

AM:

Built-in ferrite bar antenna

General

Power requirements

Sony AC Power Adaptor connected at the DC IN 3V jack:

120 V AC, 60 Hz (Models for USA, Canada, Mexico, and Taiwan)

230 V AC, 50/60 Hz (Models for continental Europe and Chili)

240 V AC, 50 Hz (Model for Australia)

220 V AC, 50 Hz (Model for China)

230 V AC, 50 Hz (Models for U.K. and Hong Kong)

220 V AC, 60 Hz (Model for Korea)

100 - 120 V/220 - 240 V AC, 50/60 Hz

(Other models)

The recorder:

Nickel metal hydride rechargeable battery

NH-7WMAA 1.2V 700 mAh (MIN) Ni-MH

LR6 (size AA) alkaline battery

Battery operation time³⁾

See "Battery life" (page 67)

Dimensions

Approx. 81.0 \times 27.7 \times 74.4 mm (w/h/d)

(3¹/₄ \times 1¹/₈ \times 3 in.)

Mass

Approx. 103 g (3.6 oz) the recorder only

¹⁾The LINE IN (OPTICAL) jack is used to connect either a digital (optical) cable or a line (analog) cable.

²⁾The  jack connects either headphones/earphones or a line cable.

³⁾Measured in accordance with JEITA.

US and foreign patents licensed from Dolby Laboratories.

Design and specifications are subject to change without notice.

Optional accessories

Optical Cable

POC-15B, POC-15AB, POC-DA12SP

MDR-series stereo headphones/earphones*

SRS-series active speakers

Your dealer may not handle some of the above listed accessories. Please ask the dealer for detailed information about the accessories in your country.

* When using optional headphones, use only headphones/earphones with stereo mini plugs. You cannot use headphones/earphones with micro plugs.

Troubles and solutions

If you find any troubles operating the recorder, follow the steps below.

- 1 Check this section, “Troubles and solutions” (page 72).
You may find the solution of your trouble on “Messages” (page 78) as well. Check the information.
- 2 If you cannot solve the problem after you made checks, consult your nearest Sony dealer.

While charging

Symptom	Cause/Solution
The rechargeable battery does not start charging. The rechargeable battery cannot be fully charged.	<ul style="list-style-type: none">• The rechargeable battery has been inserted incorrectly or the AC power adaptor has been connected incorrectly. ➔ Insert the battery correctly or connect the AC power adaptor correctly.
The recorder become hot during the charging procedure.	<ul style="list-style-type: none">• This is not a trouble and poses no danger.

While recording



Symptom	Cause/Remedy
The recorder overwrites existing materials when record.	<ul style="list-style-type: none">• The record starting-position setting (“R-Posi”) is set to “FrHere”. ➔ Set “R-Posi” setting to “Fr End”.
The recording starts from the end of the disc even when “R-Posi” is set to “FrHere”.	<ul style="list-style-type: none">• The group recording (“G-REC”) is set to “G-ON”. (You cannot overwrite tracks when “G-REC” is set to “G-ON”.) ➔ Set the group recording setting to “G-OFF” (page 56).
“R-Posi” (the record-starting point) cannot be set to “FrHere”.	<ul style="list-style-type: none">• The group recording (“G-REC”) is set to “G-ON”. ➔ Set the group recording setting to “G-OFF” (page 56), and then set “R-Posi” to “FrHere”.

Symptom	Cause/Remedy
Recording cannot be done correctly.	<ul style="list-style-type: none"> • Audio sources may not be securely connected. <ul style="list-style-type: none"> ➔ Disconnect the audio sources once and connect them again (pages 20, 23). • There is no digital signal from the portable CD player. <ul style="list-style-type: none"> ➔ When recording digitally from a portable CD player, use the AC power adaptor and disable the anti-skip function (such as ESP) on the CD player (page 23). • The analog recording was made using a connecting cord with an attenuator. <ul style="list-style-type: none"> ➔ Use a connecting cord without an attenuator. • Recording level is too small to record (when adjusting the recording level manually). <ul style="list-style-type: none"> ➔ Pause the recorder and adjust the recording level (page 34). • The power sources was disconnected or a power outage occurred during recording. <ul style="list-style-type: none"> ➔ The recording result is not recorded on the disc. Make recording again. • The premastered MD is inserted. <ul style="list-style-type: none"> ➔ Replace to the recordable MD. • The remaining recordable time on the disc is 12 seconds or less (“FULL” appears). <ul style="list-style-type: none"> ➔ Replace the disc.
Recording stops automatically while recording.	<ul style="list-style-type: none"> • You tried to overwrite a track which is checked out from the computer. (Tracks that are checked out from the computer cannot be overwrite. The recording stops automatically.) <ul style="list-style-type: none"> ➔ Check back the checked out track into the computer. ➔ Record from the end of the disc.
Stereo sound is heard in the headphones/earphones while recording in monaural.	<ul style="list-style-type: none"> • This is normal. During digital recording, the sound will be stereo in the headphones/earphones, even though the recorded sound is monaural.
Momentary noise is heard when recording.	<ul style="list-style-type: none"> • Due to the special digital audio compression technology used in LP4 stereo mode, momentary noise may occur on very rare occasions with certain sound sources. <ul style="list-style-type: none"> ➔ Record in SP or LP2 mode.
The lid does not open after recording.	<ul style="list-style-type: none"> • The lid does not open until “Edit” disappears in the display.

Symptom	Cause/Remedy
“TrFULL” appears even before the disc has reached the maximum recording time (60, 74, or 80 minutes) and the recording cannot be done.	<ul style="list-style-type: none"> This is due to the MiniDisc system limitation. When 254 tracks have been recorded on the disc, “TrFULL” appears regardless of the total recorded time. More than 254 tracks cannot be recorded on the disc. <ul style="list-style-type: none"> ➔ To continue recording, erase unnecessary tracks.
The remaining recording time does not increase even after erasing numerous short tracks.	<ul style="list-style-type: none"> This is due to the MiniDisc system limitation. Tracks of under 12 seconds (in SP stereo), 24 seconds (in LP2 stereo mode or monaural), or 48 seconds (in LP4 stereo mode) in length are not counted and so erasing them may not lead to an increase in the recording time.

While playing

Symptom	Cause/Remedy
An MD is not played normally.	<ul style="list-style-type: none"> Repeat play is selected. <ul style="list-style-type: none"> ➔ Use MENU on the recorder to change back to the normal play. Playback mode is changed. <ul style="list-style-type: none"> ➔ Use MENU on the recorder to change back to the normal play.
An MD is not played from the first track.	<ul style="list-style-type: none"> Disc playing stopped before it came to the last track. <ul style="list-style-type: none"> ➔ Press ► (or ► on the remote control) for 2 seconds or more to start playing
Playback sound skips.	<ul style="list-style-type: none"> The recorder is placed where it receives continuous vibration. <ul style="list-style-type: none"> ➔ Put the recorder on a stable place. A very short track may cause sound to skip. <ul style="list-style-type: none"> ➔ Try not to create a track under one second long.
Sound has a lot of static.	<ul style="list-style-type: none"> Strong magnetism from a television or such device is interfering with operation. <ul style="list-style-type: none"> ➔ Move the recorder away from the source of strong magnetism.
The volume of the recorded track is low.	<ul style="list-style-type: none"> The track was recorded in analog (When recorded in digital, the recording level will be automatically adjusted as same as the sound source), or you used a connecting cord with an attenuator. <ul style="list-style-type: none"> ➔ Use a correct connecting cord. The recording level was low. <ul style="list-style-type: none"> ➔ Adjust the recording level manually when recording.
Volume cannot be turned up.	<ul style="list-style-type: none"> AVLS is on. <ul style="list-style-type: none"> ➔ Release AVLS settings (page 59).

Symptom	Cause/Remedy
No sound comes through the headphones/earphones.	<ul style="list-style-type: none"> The headphones/earphones plug is not firmly connected. <ul style="list-style-type: none"> ➔ Plug in the plug of the headphones/earphones firmly to the remote control. Plug in the plug of the remote control firmly to . The plug is dirty. <ul style="list-style-type: none"> ➔ Clean the plug.
The recorder skips to several tracks ahead or behind when you press ⏮ or ⏭ on recorder.	<ul style="list-style-type: none"> The GROUP button has been pressed ( is flashing in the display). <ul style="list-style-type: none"> ➔ The recorder returns to normal if no operation has made for 5 seconds.
The edited tracks may exhibit sound dropout during search operations.	<ul style="list-style-type: none"> This occurs due to the MiniDisc system limitation. The fragmentation of data may cause sound dropout while searching because the tracks are played in higher speed than normal playback.
R-channel sound is not output when playing a track recorded from a cassette deck or an amplifier, or when listening a track with connected cassette deck or through an amplifier.	<ul style="list-style-type: none"> R-channel sound is not output if connecting to a cassette deck or an amplifier with a monaural cord. <ul style="list-style-type: none"> ➔ Make sure to use a stereo connecting cord. However, if the connected equipment is a monaural specification, R-channel sound will not be output even if connecting with stereo connecting cord.

While Editing

Symptom	Cause/Remedy
The lid does not open.	<ul style="list-style-type: none"> The power sources have been disconnected during recording or editing, or the battery have been exhausted. <ul style="list-style-type: none"> ➔ Set the power sources again, or replace the exhausted battery with new ones.
Editing could not be done.	<ul style="list-style-type: none"> The power sources have been disconnected or a power outage occurred while editing. <ul style="list-style-type: none"> ➔ Editing result up to that point is not recorded on the disc. Do the editing operation again
The tracks that are checked out from your computer cannot be erased.	<ul style="list-style-type: none"> This is due to the MiniDisc system limitations. To erase a track that has been checked out from your computer, check it back in first, and then erase it using the SonicStage software.

Symptom	Cause/Remedy
Track marks cannot be erased.	<ul style="list-style-type: none"> This is due to the MiniDisc system limitations. When the data of a track is fragmented, the track mark of a fragment under 12 seconds long (recorded in SP stereo), 24 seconds long (recorded in LP2 stereo mode or monaural mode), or 48 seconds long (recorded in LP4 stereo mode) cannot be erased. You cannot combine tracks recorded in different recording modes, e.g., a track recorded in stereo and a track recorded in monaural; nor can you combine a track recorded with digital connection and a track recorded with analog connection.
The disc cannot be edited on another component.	<ul style="list-style-type: none"> The component does not support LP2 stereo or LP4 stereo. ➔ Edit on other component that support LP2 stereo or LP4 stereo.
“TrFULL” appears even before the disc has reached the maximum track number or recording time.	<ul style="list-style-type: none"> This is due to the MiniDisc system limitation. Repeated recording and erasing may cause fragmentation and scattering of data. Although those scattered data can be read, each fragment is counted as a track. In this case, the number of tracks may reach 254 and further recording is not possible. To continue recording, erase unnecessary tracks.

While using group function

Symptom	Cause/Remedy
The group function does not operate.	<ul style="list-style-type: none"> While using a disc with no group setting, an attempt was made to select some group-related menu. ➔ Use a disc with group setting.
A track cannot be recorded to a new group. A new group cannot be created.	<ul style="list-style-type: none"> This is due to the MiniDisc system limitations. Group information has been written to the area where the disc name is stored. The disc name and track names are recorded in the same area, which can store a maximum of approximately 1,700 characters. If the total number exceeds this amount, a new group cannot be created even though group mode is on. It is also impossible to make group settings at this time.

While using the radio

Symptom	Cause/Remedy
The radio does not operate.	<ul style="list-style-type: none"> The supplied remote control is connected to other unit than this recorder. The supplied remote control should be used with this recorder only. After confirming that “NO DISC” has disappeared from the display on the remote control, press RADIO ON/OFF again on the remote control.

Symptom	Cause/Remedy
□ flashes in the display on the remote control and the radio does not operate.	<ul style="list-style-type: none"> • The rechargeable battery or the alkaline dry battery is used up. <ul style="list-style-type: none"> — Charge the battery or replace the battery with new LR6 (size AA) alkaline dry battery (page 18).

Others

Symptom	Cause/Remedy
The recorder does not work or works poorly.	<ul style="list-style-type: none"> • The rechargeable battery is not charged. <ul style="list-style-type: none"> ➔ Charge the rechargeable battery. • The volume is low. <ul style="list-style-type: none"> ➔ Turn up the volume. • No disc is inserted. <ul style="list-style-type: none"> ➔ Insert a recorded disc. • The HOLD function is turned on (“HOLD” appears in the display when you press an operation button on the recorder). <ul style="list-style-type: none"> ➔ On the recorder, disable HOLD by sliding the HOLD switch to the opposite direction of the arrow. • The lid is not firmly closed. <ul style="list-style-type: none"> ➔ Close the lid until it clicks. Then slide OPEN to open the lid. • Moisture has condensed inside the recorder. <ul style="list-style-type: none"> ➔ Take the MD out and leave the recorder in a warm place for several hours until the moisture evaporates. • The rechargeable battery or dry battery is weak (“LoBATT” flashes or nothing appears). <ul style="list-style-type: none"> ➔ Charge the rechargeable battery or replace the dry battery with the new one, or connect the supplied AC power adaptor to the recorder. • The dry battery have been inserted incorrectly. <ul style="list-style-type: none"> ➔ Insert the battery correctly. • The disc is damaged or does not contain proper recording or editing data. <ul style="list-style-type: none"> ➔ Reinsert the disc. Rerecord the disc. If the error message still appears, replace it with another disc. • While operating, the recorder received a mechanical shock, too much static, abnormal power voltage caused by lightning, etc. <ul style="list-style-type: none"> ➔ Restart the operation as follows. <ol style="list-style-type: none"> 1 Disconnect all the power sources. 2 Leave the recorder for about 30 seconds. 3 Connect the power source.

Messages

If the following error messages flash in the display window, check the chart below.

Error message	Meaning/Remedy
AVLS	<ul style="list-style-type: none">• AVLS is set to "ON" so that the volume will not increase anymore. ➔ Set AVLS to "OFF" (page 59).
🔒FULL	<ul style="list-style-type: none">• You tried to set the 21st bookmark. ➔ You can set up to 20 bookmarks. Set bookmarks within 20.
BLANK	<ul style="list-style-type: none">• An MD with no recording on it is inserted.
BUSY	<ul style="list-style-type: none">• You tried to operate the recorder while it was accessing the recorded data. ➔ Wait until the message goes out (in rare cases, it may take a few minutes).
CannotCHG	<ul style="list-style-type: none">• You tried to charge at a place where the temperature is too high. ➔ Charge the battery at a temperature of 5°C (+41°F) to +40°C (+104°F).
Edit	<ul style="list-style-type: none">• The MD player is recording information (track start and end position) from the memory to the disk. ➔ Wait until this process is completed. Do not expose the player to physical shock, nor disrupt power supply.
ERROR	<ul style="list-style-type: none">• There is an internal malfunction in the system. ➔ Restart the operation by doing steps 1 to 3 on page 77. If the message appears again, please consult your nearest Sony dealer.
FULL	<ul style="list-style-type: none">• The remaining recording time on the disc is 12 seconds (stereo), 24 seconds (LP2 stereo or monaural), 36 seconds (LP4 stereo), or less. ➔ Replace the disc.• You tried to enter more than 200 letters to label a single track or disc.• You tried to enter a total of more than 1,700 letters for track or disc names.• You tried to create a 100th group. ➔ You can create only up to 99 groups on a disc. Keep the group number within 99.
HiDCin	<ul style="list-style-type: none">• Voltage of the power supply is too high (The supplied AC power adaptor or the recommended car battery cord is not used). ➔ Use the supplied AC power adaptor or the recommended car battery cord.
HOLD	<ul style="list-style-type: none">• The recorder is locked. ➔ Slide HOLD against the arrow to unlock the recorder (page 20).

Error message	Meaning/Remedy
LoBATT	<ul style="list-style-type: none"> • Battery is weak. ➔ Replace the dry battery (page 18).
MEMORY	<ul style="list-style-type: none"> • You tried to record with the recorder placed where it receives continuous vibration. ➔ Put the recorder on a stable place, and start recording again.
NO CHG	<ul style="list-style-type: none"> • You tried to charge at a place where the temperature is too high. ➔ Charge the battery at a temperature of +5°C (+41°F) to +40°C (+104°F).
NoCOPY	<ul style="list-style-type: none"> • You tried to make a copy from a disc that is protected by the Serial Copy Management System. You cannot make copies from a digitally connected source which was itself recorded using digital connection. ➔ Use analog connection instead (page 32).
NoDISC	<ul style="list-style-type: none"> • You tried to play or record with no disc in the recorder. ➔ Insert an MD.
NoEDIT	<ul style="list-style-type: none"> • You selected “G : Ers” with a disc without group setting. ➔ You cannot erase groups with a disc with no groups. • You selected, “G : Set”, “G : Rls”, “Move”, or “Erase” while recording. • You tried to erase the track mark at the beginning of the first track or group. • You tried to erase a track mark to combine tracks the recorder cannot combine (a track recorded in stereo and in mono, for example). • You tried to overwrite a track marks.
NoMARK	<ul style="list-style-type: none"> • You selected bookmark play without setting bookmarks. ➔ Set bookmarks (page 57).
NO OPR	<ul style="list-style-type: none"> • You tried to set Auto Time Mark while recording through digital connection. • You tried to press ■■ or T MARK during synchro-recording.
No SIG	<ul style="list-style-type: none"> • The recorder could not detect digital input signals. ➔ Make sure that the source is connected firmly (page 23).
PbONLY	<ul style="list-style-type: none"> • You tried to record or edit on a pre mastered MD (Pb stands for “playback”). ➔ Insert a recordable MD.
Rd ERR	<ul style="list-style-type: none"> • The recorder cannot read the disc information correctly. ➔ Reinsert the disc.

Error message	Meaning/Remedy
Rec ERR	<ul style="list-style-type: none"> • Recording was not correctly done. <ul style="list-style-type: none"> ➔ Place the recorder at a place with no vibrations and record again. • The disc is soiled with an oil film or finger prints, is scratched, or is not a standard disc. <ul style="list-style-type: none"> ➔ Try recording again with another disc.
SAVED	<ul style="list-style-type: none"> • You tried to record or edit on a MD with the tab in the record-protect position. <ul style="list-style-type: none"> ➔ Slide the tab back (page 69).
Saving	<ul style="list-style-type: none"> • The MD player is recording information (sounds) from the memory to the disc. <ul style="list-style-type: none"> ➔ Wait until this process is completed. Do not expose the player to any physical shock, nor disrupt power supply.
SEL GR	<ul style="list-style-type: none"> • You selected “G : Name”, “G : Move”, or “G : Ers” while the recorder is stopped or while playing a track that does not belong to a group. <ul style="list-style-type: none"> ➔ Select a track within a group you want to edit, and then do the editing operation again.
TEMP	<ul style="list-style-type: none"> • Heat has built up in the recorder. <ul style="list-style-type: none"> ➔ Let the recorder cool down.
TOC ERR	<ul style="list-style-type: none"> • The recorder cannot read the disc information correctly. <ul style="list-style-type: none"> ➔ Insert another disc. ➔ If it is no problem to erase the entire disc, do so (page 44).
TrFULL	<ul style="list-style-type: none"> • Track number 254 has been reached. <ul style="list-style-type: none"> ➔ Erase unnecessary tracks (page 44).
TrPROT	<ul style="list-style-type: none"> • You tried to record or edit on a track that is protected from erasing. <ul style="list-style-type: none"> ➔ Record or edit on other tracks. • You tried to edit a track that has been checked out from a computer. <ul style="list-style-type: none"> ➔ Check the track back in to the computer and then edit.

Explanations

Difference between digital (optical) and analog (line) inputs

The input jack of this recorder works as both digital and analog input jacks. Connect the recorder to a CD player or a cassette recorder using either digital (optical) input or analog (line) input. To record, see “Recording an MD right away!” (page 22) to record using digital (optical) input, and “Recording from a TV or a radio (Analog Recording)” (page 32) to record using analog (line) input.

Difference	Digital (optical) input	Analog (line) input
Connectable source	Equipment with an digital (optical) output jack (CD player, DVD player, etc.)	Equipment with an analog (line) output jack (Cassette deck, radio, record player, etc.)
Usable cord	Optical cable (with an optical or an optical-mini plug) (page 23)	Line cable (with 2 phono plugs or a stereo-mini plug) (page 32)
Signal from the source	Digital	Analog Even when a digital source (such as a CD) is connected, the signal sent to the recorder is analog.
Track marks ¹⁾	Marked (copied) automatically <ul style="list-style-type: none">• at the same positions as the source (when the sound source is a CD or an MD).• after more than 2 seconds of no sound (page 82) or low-level segment (with a sound source other than a CD or an MD).• when the recorder is paused (3 seconds of no sound is encountered while synchro-recording)	Marked automatically <ul style="list-style-type: none">• after more than 2 seconds of no sound (page 82) or low-level segment.• when the recorder is paused while recording.
Recorded sound level	Same as the source. Can also be adjusted manually (Digital REC level control) (“Adjusting the recording level manually”, page 34).	Adjusted automatically. Can also be adjusted manually (“Adjusting the recording level manually”, page 34).

¹⁾ You can erase unnecessary marks after recording. (“Combining tracks (Combine)”, page 43).

Note

Track marks may be copied incorrectly:

- when you record from some CD players or multi disc players using digital (optical) input.
- when the source is in shuffle or program play mode while recording using digital (optical) input. In this case, play the source in normal play mode.
- when programs with audio that is digitally broadcast (e.g., digital TV) are recorded through the digital (optical) input.

The meaning of “no sound”

“No sound” describes a recorder condition in which the input level is about 4.8 mV during analog input or less than -89 dB during optical (digital) input (with 0 dB as full bit (the maximum recordable level for a MiniDisc)).

Note on digital recording

This recorder uses the Serial Copy Management System, which allows only first-generation digital copies to be made from premastered software. You can only make copies from a home-recorded MD by using the analog (line out) connections.

Premastered software such as CDs or MDs.

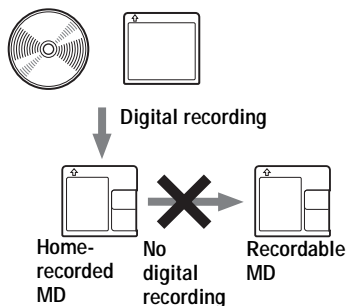

Microphone, record player, tuner, etc. (with analog output jacks).

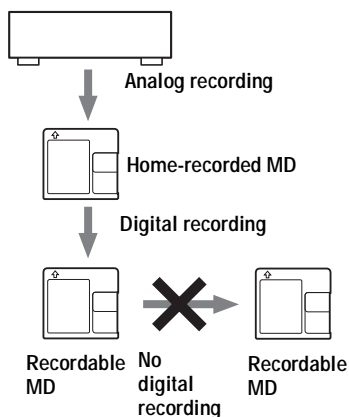

Restrictions on the editing of tracks checked out from your computer

This unit was designed so that editing functions (i.e., erasing tracks, adding track marks, and erasing track marks) do not function for tracks that have been checked out from your computer. This is to prevent the loss of check-in authorization by the checked-out tracks. To edit these tracks, first check them back into the computer, and then edit them on the computer.

About the DSP TYPE-S for ATRAC/ATRAC3

This recorder supports DSP TYPE-S, a specification for high-level Sony MiniDisc decks equipped with digital signal processors (DSP). This specification allows the recorder to produce high-quality sound from tracks recorded in MDLP mode. Since it retains DSP TYPE-R support, the recorder produces superior results during recording or playback in SP (normal stereo) mode.

Suppressing the skips of the sound (G-PROTECTION)

The G-PROTECTION function was developed to provide a higher level of shock resistance than that of existing players.

Recording audio data to your computer

You can record audio data to your computer from sources such as audio CDs and the Internet (page 92).



Audio CDs



Internet



On the computer

Listening

You can listen to an audio CD in the CD-ROM drive of your computer, or audio data in the hard disk drive (page 99).



What is a Net MD?

Net MD is a standard that enables the transfer of audio data from a computer to a MiniDisc device. To use this Net MD with your computer requires a software application called “SonicStage”.

SonicStage software provides a database for managing audio data in the computer and functions for playing the audio data in various play modes, editing the data, and transferring the results to other devices and hardware connected to the computer. It is an integrated software application with a variety of functions for enjoying music.

Transferring audio data to the Net MD

You can transfer audio data stored in your computer to an MD (page 96).

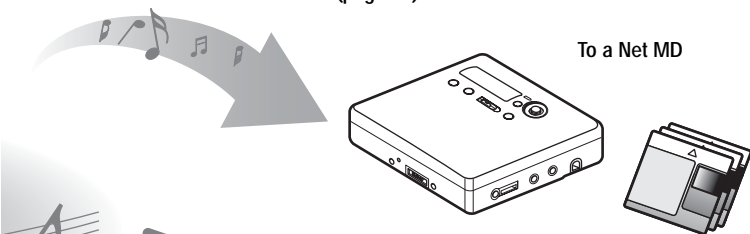

Editing

You can easily edit audio data or add labels from the keyboard (page 95).



Creating a music library

You can create a music library of your favorite songs on your computer.



Basic operational flow using the Net MD

The following is the basic steps that you will take following the purchase of your recorder. Through these steps, you will prepare and set up your computer for use of your recorder as a Net MD. Do the following steps, and refer to the indicated pages for details.

1 Providing the required system environment.

(page 87)

2 Installing the software onto your computer.

(page 88)

3 Connecting the Net MD to your computer.

(page 91)

4 Storing audio data to your computer.

In this manual, recording from an audio CD is explained.

(page 92)

5 Transferring audio data from your computer to an MD (Check-out).

(page 96)

6 Listening to an MD.

You can listen to audio data that have been checked out from your computer to your Net MD.

(page 99)

Providing the required system environment

System requirements

The following hardware and software are required in order to use the SonicStage software for the Net MD.

Computer	IBM PC/AT or Compatible
	<ul style="list-style-type: none">• CPU: Pentium II 400 MHz or higher (Pentium III 450 MHz or higher is recommended.)• Hard disk drive space¹⁾: 120 MB or more• RAM: 64 MB or higher (128 MB or higher is recommended)
	Others
	<ul style="list-style-type: none">• CD-ROM drive (capable of digital playback by WDM)• Sound Board• USB port (supports USB (previously USB 1.1))
Operating System	Factory installed: Windows XP Home Edition/Windows XP Professional/Windows Millennium Edition/Windows 2000 Professional/Windows 98 Second Edition
Display	High Color (16bit) or greater, 800 × 480 dots or more (800 × 600 dots or more is recommended)
Others	<ul style="list-style-type: none">• Internet access: for Web registration and EMD services• Windows Media Player (version 7.0 or higher) installed for playing WMA files

¹⁾ See page 105 for details.

This software is not supported by the following environments:

- Macintosh
- Windows XP versions other than Home Edition or Professional
- Windows 2000 versions other than Professional
- Windows 98 versions other than Second Edition
- Windows NT
- Windows 95
- Personally constructed PCs or operating systems
- An environment that is an upgrade of the original manufacturer-installed operating system
- Multi-boot environment
- Multi-monitor environment

Notes

- We do not ensure trouble-free operation on all computers that satisfy the system requirements.
- We do not ensure trouble-free operation of the system suspend, sleep, or hibernation function on all computers.

Installing the software onto your computer

This section explains the installation of the SonicStage Ver.1.5 software supplied with your Net MD.

Before installing the software

1 Make sure to note the following before installing the software.



Do not connect the dedicated USB cable before the installation!

The SonicStage software may not correctly load or operate if the dedicated USB cable is connected to your computer during the installation.



Close all other Windows applications before starting the installation!

Make sure to close any virus-check software, as such software usually demand large amounts of system resources.

2 Depending on the following operating system or software already installed on your computer, refer to the reference pages before installing the software.

Windows XP → page 102	<ul style="list-style-type: none">• To install this software, you must log on with a user name with “Computer Administrator”.• If you perform the “System Restore” function in the Windows “System Tools” menu, the tracks managed by SonicStage may become corrupted and rendered unplayable.
Windows Millennium Edition → page 103	<ul style="list-style-type: none">• If you perform the “System Restore” function of the Windows “System Tools” menu, the tracks managed by SonicStage may become corrupted and rendered unplayable.
Windows 2000 → page 103	<ul style="list-style-type: none">• You must log on as “Administrator” before installing the software.
OpenMG Jukebox, SonicStage, or SonicStage Premium → page 104	<ul style="list-style-type: none">• Depending on the version of your software, the existing software may be overwritten by the new version or it may co-exist with SonicStage Ver.1.5. As the installation process will depend on the version, see the reference page for details.

Installing SonicStage Ver.1.5

1 Turn on your computer and start up Windows.

2 Insert the installation CD-ROM for SonicStage into the CD-ROM drive of your computer.

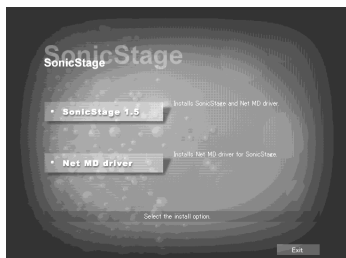

The setup program starts up automatically and the SonicStage Ver.1.5 installation window appears.

3 Click to select [SonicStage 1.5].

To use this software with the Net MD, you must install SonicStage Ver.1.5 and the Net MD driver.

Click [SonicStage 1.5]

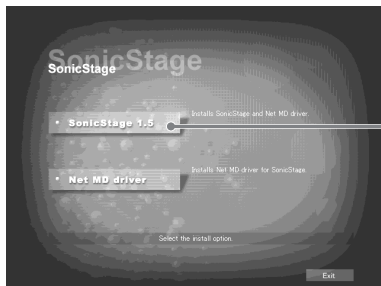

- When installing SonicStage for the first time
- When SonicStage, SonicStage Premium, or OpenMG Jukebox is installed on the computer

continued

4 Follow the displayed instructions.

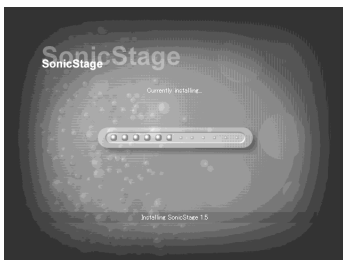

Read the instructions carefully. The installation may take 20 to 30 minutes, depending on your system environment (page 111).

5 After the installation is completed, click [Restart] to restart the computer.

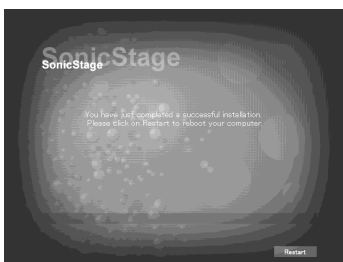

Make sure to restart your computer only after the installation has completed.

Was the installation successful?

If any trouble occurs during the installation, see “Troubleshooting” (page 108).

Notes

- Do not delete, move, or edit any of the installed folders using Explorer or any other application. Doing so could cause the SonicStage database to become unstable or corrupted.
- While the installation is still in progress, do not interrupt the operation or take the CD-ROM out of the CD-ROM drive. Doing so may render it impossible to install the software thereafter.

Connecting the Net MD to your computer

After the software installation is completed, connect the Net MD to your computer. Refer to the operating instructions of the Net MD as well.

- 1 Insert a recordable disc into the Net MD.
 - 2 Make the power source and the dedicated USB cable connections with the Net MD and the computer.
-

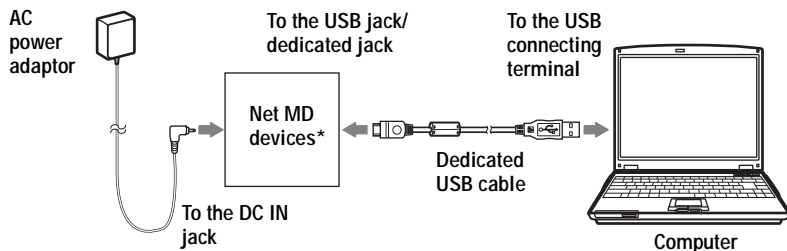

* If a cradle is supplied with your Net MD, connect the dedicated USB cable to the USB cradle and place the Net MD onto the USB cradle.

- 3 Check the connections.

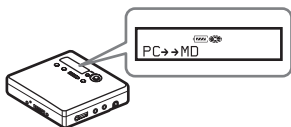

When the connections have been properly made, “PC→MD”^{*} appears in the display of the Net MD.

^{*}Depending on the device, “Net MD” may be displayed.

Notes

- When using the Net MD connected to your computer, it is recommended that you run the recorder from an AC outlet. If you use a battery to run the Net MD, be sure to use a new dry cell or a fully charged rechargeable battery. We do not assure the results should there be a mis-operation, check-out failure, or destruction of audio data caused by insufficient battery power.
- When using the Net MD with the cradle, place the cradle on a stable surface so that the dedicated USB cable does not become detached.

Storing audio data to your computer

This section explains how to record and store audio data from an audio CD to the hard disk drive of your computer.

The procedure in this section is used to record all tracks on an audio CD. To record only specific tracks from a CD, or from other sound sources, see the online help for details (page 100).

Note

The system may malfunction if your computer changes to system suspend or hibernation mode while the software is playing, recording, or connecting to an external device or media* such as a Net MD. Make sure to disable any changes to suspend or hibernation mode. See page 105 for details.

* For this software, the word “MD” refers to the built-in MD slot on the computer, and “Device/Media” to a Net MD that is externally connected over a USB cable.

Starting SonicStage

Do one of the following:

- Double click  ([SonicStage] icon) on the computer.
- Select [Start] - [Programs]* - [SonicStage] - [SonicStage].

* [All Programs] in the case of Windows XP

SonicStage starts up and the main window appears.

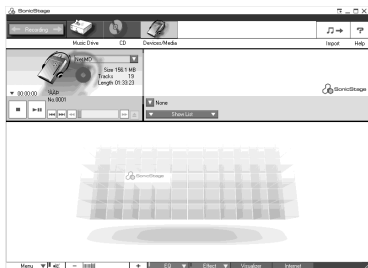

Recording audio CDs to the hard disk drive

In SonicStage Ver.1.5, the hard disk drive is called the “Music Drive”. The Music Drive manages all audio data stored by SonicStage.

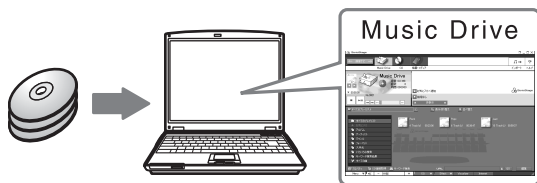

-
- 1 Insert the audio CD that you want to record into the CD-ROM drive of your computer.



The CD window appears in the display.

Note

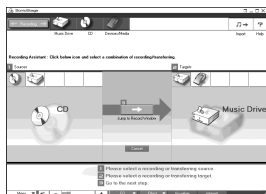

When you record an audio CD from your CD-ROM drive for the first time, the “CD Drive Optimization” dialog box appears when you insert the audio CD. Clicking [Start] initiates a check of the CD-ROM drive to verify that the CD-ROM drive is able to perform the recording properly.

-
- 2 Click .



The recording navigation window* appears in the display.

*The recording navigation window makes it easy to make a recording. Simply by doing **1**, **2** and **3** in the next step, you can select the audio source in the left panel and the recording destination in the right panel.

-
- 3 Select  (CD) for [**1** Sources] and  (Music Drive) for [**2** Targets], then click **3**  [Jump to Record Window].

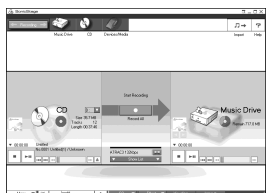

The display changes to the recording window.

-
- 4 Click **ATRAC3 132kbps**  in the middle of the recording window and select the recording mode.

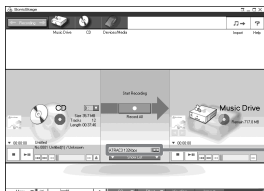

When recording data in LP2 mode:
select ATRAC3 132kbps

When recording data in LP4 mode:
select ATRAC3 66kbps

-
- 5 If the list panel is not displayed, click .



List panels appear under the recording window. The contents of the audio CD appear in the left list panel.

-
- 6 Click  [Record All].

Recording starts.

Upon completion, recorded tracks appear in the right list panel.

To stop recording

Click  ([Stop]).

To resume recording, click . When recording is resumed, it starts from the beginning of the track that was last stopped.

Labeling audio data

After recording has completed, you can label the audio data in the Music Drive. Once audio data in the Music Drive is labeled, the label information will be transferred to a disc along with the audio data, allowing you to view the data on your Net MD.

- 1 Start up SonicStage (page 92) and click  (Music Drive).



“All Playlists” appears and all the albums stored on the Music Drive appear in the Music Drive window.

- 2 Double click the desired album name.

A list of the audio files in that album appears.

- 3 Click  in the lower right part of the display.





The editing panel appears in the display.

- 4 Select an item by clicking [Title], [Album], [Artist], or [Genre], and then right-click and select [Rename].

You can also click [▼] at [Album] or [Artist] to display a dropdown list, and then select an item from the list.

- 5 When the track title is highlighted, enter the text data from the keyboard.
-

 You can also import names from a database with the  ([CD Info]) button for use in labeling tracks or albums. See the online help for details (page 100).

Transferring audio data from your computer to the Net MD (Check-out)

Audio data stored on the Music Drive can be transferred to your Net MD. This process is called “Check-out”. The number of times a track can be checked out is restricted in this software for the protection of copyrights (page 114).







Checking out audio files to the Net MD

This section explains how to check out all audio files in a playlist*.

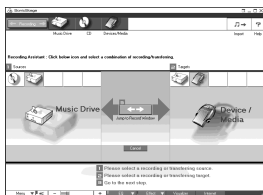
* A playlist is a container that allows the stored audio files in the Music Drive to be classified by genre, artist, etc.

-
- 1 Click  to display the recording navigation window.



-
- 2 Select  (Music Drive) for [1 Sources] and  (Device/Media) for [2 Targets], then click  ([Jump to Record Window]).
The display changes to the recording window.
-

-
- 3 Click **Normal**  in the middle of the display and select the recording mode (page 94).

Standard transfer mode: Data are transferred in the format of the original files.

Maximum available transfer space: All data are transferred in LP4 mode.

SP transfer mode: All data are converted and transferred in normal stereo mode. Select this mode if you listen to checked-out data on equipment that does not support MDLP mode.



-
- 4 If the list panel is not displayed, click **Show List** .

A playlist appears in the display.



-
- 5 Confirm that the audio files you are about to check out are okay for checking out.



The music notations beside the track number in the left panel of the list represent the number of times the file can be checked out (e.g.  = the track can be checked out three more times). If  appears beside the track number, the file cannot be checked out.

-
- 6 Click  [Check-Out All].

Checking out of the files starts.

All files in the playlist are checked out to the connected Net MD.

To cancel a check-out

Click  ([Stop]).

Notes

- Once a check-out (or check-in) has started, do not disconnect the dedicated USB cable or power source until the check-out operation has completed. These actions may damage the data or cause the system to malfunction.
- Make sure not to bump the Net MD after check-out has started. If you do, the contents of the recording may not be stored correctly.
- Due to the limitations of the MD system, you may not be able to record the full amount of remaining recording time.
- Due to the limitations of the MD system, a maximum of about 1,700 characters can be stored for disc name, group names and track names on the disc. Take note of this fact when checking out a large number of tracks.

Listening to an MD

You can listen to an MD on the Net MD while it is connected to your computer. When disconnected from your computer, the Net MD can be used as an ordinary MiniDisc device.

For details on Net MD operations, refer to the “Recorder Operations” section.

Listening to an MD with the Net MD connected to the computer

If you listen to an MD with the Net MD connected to the computer, be sure to listen with the Net MD itself (connecting to the headphones/earphones, speakers, etc.). The MD sound cannot be heard from headphones/earphones that are connected to the computer.

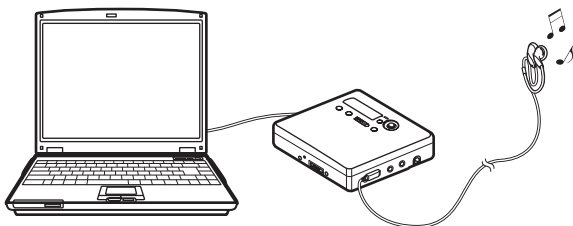

Listening to an MD with the Net MD disconnected from the computer

Listen to the MD after disconnecting the dedicated USB cable from the computer and the Net MD.

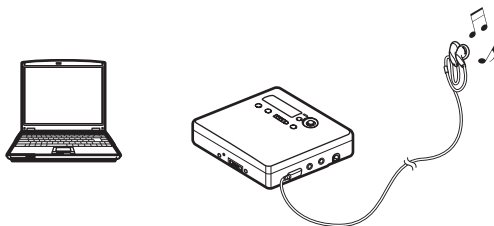

Notes

Generally, you cannot erase or divide/combine checked-out audio files. If you want to edit such files, check them back in first. Checked-out files can be edited on some MD devices; however, erasing a track will decrease the number of times the file can be checked out, and dividing or combining tracks will render the file impossible to check back into the computer (page 112).

Using other functions!

Using the SonicStage online help

This manual explains only the basic operations of the SonicStage software. However, the software has a host of other functions that allow you to carry out various operations, such as importing audio files from the Internet, classifying and managing audio files, and playing in various play modes. For information and details on the various menus and operations, go to the online help.

To display online help

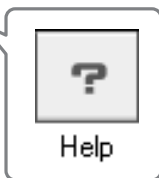

Click  (help) while the SonicStage software is running.



You can display the online help by selecting the following:
[Start]–[Programs]*–[SonicStage]–[SonicStage Help]

* [All Programs] in the case of Windows XP.

Viewing online help

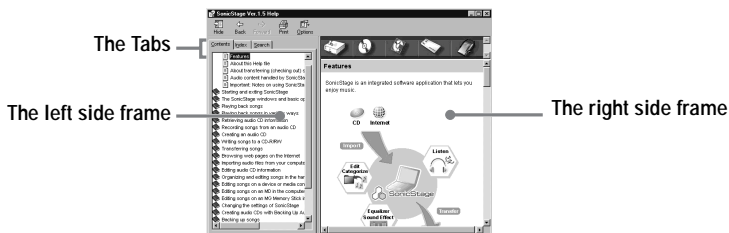

Let's find out how to use the online help first. An explanation on the use of the online help can also be found in the online help.

1 Double click [Overview] in the left-hand frame.

2 Click [About this Help file].

The explanation will appear in the right-hand frame.

3 Read the text.

Scroll the display if necessary.

Click underlined words to jump to their explanations.

Note

In the online help, "Device/Media" is the general term for external devices such as Net MDs, Network Walkmans (i.e., portable IC audio players or portable "Memory Stick" audio players), and MusicClips.

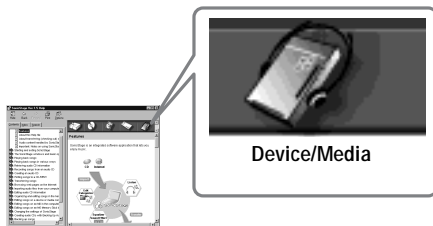

Settings and Precautions

Settings according to OS

The settings and precautions will differ according to the operating system being used. Check the items that apply to your system.

 For Windows XP users

Restrictions when running the SonicStage software under Windows XP

- To install this software, you must log on with a user name with “Computer Administrator”* as an attribute.
- You must log on with the user name “Administrators” or “Power Users” to use the SonicStage software.
- Both edition of Windows XP (Home/Professional) can be used.
- The NTFS format of Windows XP Home Edition or Windows XP Professional (factory installed) can be used only with the standard (factory) settings.

* To check whether the user name has the attribute of “Computer Administrator”
Go to [Start]- [Control Panel]-[User Account], and then check the user name displayed on the window.

When using SonicStage under Windows XP

If you use the “System Restore” function in Windows “System Tools”, audio data managed by SonicStage may become corrupted and rendered unplayable.

Before executing the system restoration procedure, you should first back up all audio files and restore them after doing the system restoration procedure.

For details about backup procedures, refer to online help.

Note

Restoring backup data requires access to the Internet. If an audio file becomes unplayable after restoring the system, an error dialog box may appear. If this occurs, do as instructed by the message.

 For Windows Millennium Edition users

When using SonicStage under Windows Millennium Edition

If you use the “System Restore” function in Windows “System Tools”, audio data managed by SonicStage may become corrupted and rendered unplayable.

Before executing the system restoration procedure, you should first back up all audio files and restore them after doing the system restoration procedure.

For details about backup procedures, refer to online help.

Note

Restoring backup data requires access to the Internet. If an audio file becomes unplayable after restoring the system, an error dialog box may appear. If this occurs, do as instructed by the message.

 For Windows 2000 users

Restrictions when running the SonicStage software under Windows 2000

- You must log on as “Administrator” to install the SonicStage software.
- You must log on with the user name “Administrators” or “Power Users” to use the SonicStage software.
- Of the Windows 2000 versions, SonicStage is supported only by Windows 2000 Professional.
- The NTFS format of Windows 2000 Professional (factory installed) can be used only with the standard (factory) settings.

 For Windows 98 Second Edition users

Importing MP3 files to the computer or playing WAV files on the computer

Microsoft Media Player version 7.0 or higher is required for importing MP3 files or playing WAV files. Users of earlier versions can download the most recent version from the Microsoft website (<http://www.microsoft.com/>).

For users with OpenMG Jukebox, SonicStage, or SonicStage Premium installed on their computer

Note

Confirm whether any tracks have been checked out from your computer. If tracks have been checked out from OpenMG Jukebox, an earlier version of SonicStage, or SonicStage Premium, it may not be possible to check those tracks back in with SonicStage Ver.1.5. It is recommended to check in the tracks before installing SonicStage Ver.1.5.

Check the following contents before installing SonicStage Ver.1.5.

The installation items and procedure will vary depending on the software installed on your computer.

Users with OpenMG Jukebox installed

Installed Version	What to do
Ver.1.0~2.1	Install SonicStage 1.5. OpenMG Jukebox Ver.1.0-2.1 is automatically uninstalled and replaced. ¹⁾
Ver.2.2	OpenMG Jukebox Ver.2.2 and SonicStage Ver.1.5 can co-exist in the computer. If you install SonicStage Ver.1.5, then OpenMG Jukebox Ver.2.2 will be automatically upgraded to the latest version.

- ¹⁾ Audio files recorded with OpenMG Jukebox Ver.1.0-2.1 are automatically converted to SonicStage Ver.1.5 files. For safety sake, it is recommended that you back up your audio data with the back-up tool before doing the upgrade to SonicStage Ver.1.5.

Users with an earlier version of SonicStage installed

Installed Version	What to do
Ver.1.0~1.5	Install SonicStage Ver.1.5. The earlier version is automatically uninstalled and replaced. ¹⁾

- ¹⁾ Audio files recorded with SonicStage Ver.1.0-1.5 are automatically converted to SonicStage Ver.1.5 files. For safety sake, it is recommended that you back up your audio data with the back-up tool before doing the upgrade to SonicStage Ver.1.5.

Users with a SonicStage Premium installed

Installed Version	What to do
SonicStage Premium	Install SonicStage Ver.1.5. SonicStage Ver.1.5 and SonicStage Premium can co-exist in the computer.

Precautions on the co-existence of SonicStage Ver. 1.5 with OpenMG Jukebox Ver.2.2 or SonicStage Premium

- Make sure the OpenMG Jukebox Ver.2.2 icon is not displayed in the task tray. If it is, the Net MD may not be recognized by your computer.
- Audio data recorded on the computer are stored in a common file and used by both applications. Therefore, if you delete an audio file (e.g., one album) in one application, it will be deleted in the other software as well.

Precaution on using a computer on which OpenMG Jukebox Ver.1.0-2.1 or SonicStage Ver.1.0-1.2 is installed

Make sure not to replace SonicStage Ver.1.5 with OpenMG Jukebox Ver.1.0-2.1 or SonicStage Ver.1.0-1.2., as all audio data in the Music Drive may be lost. If you begin the installation of OpenMG Jukebox Ver.1.0-2.1 or SonicStage Ver.1.0-1.2 by mistake, stop the installation immediately.

Note on hard disk drive space

120 MB or more free space on the hard disk drive is required. If your computer does not have enough space, the software will not be properly installed. The required free space differs according to the version of your Windows OS, or the amount of audio files that you handle.

Notes on system suspend/hibernation mode

- If the computer changes to system suspend/hibernation mode during the recording of a CD or the checking in/out of a data file, the audio data may be lost or the computer may not wake up properly. The computer suspend/hibernation function should therefore be turned off.
- If you change the media while the computer is in system suspend/hibernation mode, audio data may be lost after the computer wakes up.
- If the computer changes to system suspend/hibernation mode, the computer may not recognize the Net MD when it wakes up. If this happens, disconnect the USB cable and reconnect it again.

Backing up the audio data

Before doing any procedure that may affect the operating system itself (such as a system recovery), you should back up all of your audio data with the [SonicStage backup tool] from the [Start] - [Programs] - [SonicStage].

Uninstalling the SonicStage software

To uninstall the SonicStage software, follow the procedures below.

For Windows XP users

Log on with a user name with “Computer Administrator” as an attribute. Refer to the operating instructions of your computer for details on logging on as an administrator.

-
- 1 Click [Start]–[Control Panel].
The “Control Panel” window appears.

 - 2 Double-click [Add/Remove Programs].
The “Add/Remove Programs” dialog box appears.

 - 3 Click [Change or Remove Programs].

 - 4 Click [SonicStage 1.5.XX] in the “Currently Installed Programs” list, and then click [Change and Remove].

 - 5 Click [OpenMG Secure Module 3.1]* in the “Currently Installed Programs” list, and then click [Change and Remove].
Do as instructed by the message and restart the computer. When the computer restarts, the uninstallation will be completed.

* If SonicStage Ver.1.5 is co-existing with OpenMG Jukebox Ver.2.2 or SonicStage Premium on your computer, and you uninstall one or the other, make sure [OpenMG Secure Module 3.1] is not uninstalled since it is commonly used with both software applications.

For Windows Millennium Edition/Windows 98 Second Edition users

-
- 1 Click [Start]–[Settings]–[Control Panel].
The “Control Panel” window appears.
-

2 Double-click [Add/Remove Programs].

The Add/Remove Programs Properties window appears.

3 Click [SonicStage 1.5.XX] in the list of programs for automatic removal, and then click [Add/Remove].

4 Click [OpenMG Secure Module 3.1]* in the list of programs for automatic removal, and then click [Add/Remove].

Do as instructed by the message and restart the computer. When the computer restarts, the uninstallation will be completed.

For Windows 2000 users

Log on as “Administrator”, and then follow the instructions below.

Refer to the operating instructions of your computer for details on logging on as an administrator.

1 Click [Start]–[Settings]–[Control Panel].

The “Control Panel” window appears.

2 Double-click [Add/Remove Programs].

The “Add/Remove Programs” dialog box appears.

3 Click [Change or Remove Programs].

4 Click [SonicStage 1.5.XX] in the “Currently Installed Programs” list, and then click [Change/Remove].

5 Click [OpenMG Secure Module 3.1]* in the “Currently Installed Programs” list, and then click [Change/Remove].

Do as instructed by the message and restart the computer. When the computer restarts, the uninstallation will be completed.

* If SonicStage Ver.1.5 is co-existing with OpenMG Jukebox Ver.2.2 or SonicStage Premium on your computer, and you uninstall one or the other, make sure [OpenMG Secure Module 3.1] is not uninstalled since it is commonly used with both software applications.

Troubleshooting

Please do the following steps if you encounter a problem while using the SonicStage software. In case a message appears, it is recommended that you write it down.

Step 1: Check the symptoms in this “Troubleshooting” section.

A variety of information can also be found in the operating procedures and “Settings and Precautions” (page 102) as well.

Step 2: Check the symptoms in the SonicStage 1.5 online help (page 100).

Check “Troubleshooting” under “Additional information” in the online help. Useful information may also be found in other sections in the online help.

Step 3: If the trouble cannot be solved after checking the above references.

Check the following table and then consult your nearest Sony dealer.

Computer <ul style="list-style-type: none"> • Manufacturer: • Model: • Type: Desktop type / Laptop type
Name of operating system:
RAM capacity:
Hard disk drive (containing SonicStage and audio data) <ul style="list-style-type: none"> • Capacity of the drive: • Free space:
Installed folder containing SonicStage (if other than the default folder)¹⁾ <ul style="list-style-type: none"> • Location of the installed folder:
Version of the software (SonicStage Ver.1.5) ²⁾ :
Error Message (if one appeared):
If an externally connected CD-ROM drive is used <ul style="list-style-type: none"> • Manufacturer: • Model: • Type: CD-ROM / CD-R/RW / DVD-ROM / Other () • Type of connection to the computer: PC card / USB / IEEE1394 / Other ()
If another device with USB connection is used <ul style="list-style-type: none"> • Name of the device (or devices):

¹⁾ If you do not specify the destination, the software is installed at C:\Program Files\Sony\SonicStage.

²⁾ To check the SonicStage software version, go to [Menu] - [About SonicStage] in the SonicStage window, or see the version information on the supplied CD-ROM.

If your computer does not recognize the Net MD

- **Is the Net MD connected correctly to your computer?**

- If the Net MD is not firmly connected to the computer, the Net MD will not be recognized by your computer.
- Reconnect the dedicated USB cable. If the computer still does not recognize the Net MD, disconnect the Net MD, restart the computer, and connect the dedicated USB cable again.

- **Is an MD inserted in the Net MD?**

Check if an MD is inserted in the Net MD.

- **If your computer does not recognize your Net MD even when the Net MD is connected and a disc is inserted, the Net MD driver may not be correctly installed.**

Go to the [USB Controller] in the Windows Device Manager window to verify that your Net MD is correctly recognized.

A [!] mark in the Device Manager window indicates that your Net MD is not correctly recognized. Reinstall the Net MD driver.

1 Click [Start]–[Settings]–[Control Panel].¹⁾

2 Double click [System] in the control panel.²⁾

3 Click the [Hardware]³⁾ tab, and then click [Device Manager].

The Device Manager window appears.

¹⁾ In Windows XP, select [Start]–[Control Panel].

²⁾ In Windows XP, double click [System] if the control panel is in the “classic” format, or click [Performance and Maintenance] and then [System] if the control panel is in the “category” format.

³⁾ Depending on your system, the [Hardware] tab may not be provided. In this case, click the [Device Manager] tab to display the Device Manager window.

If the installation was not successful

- **Be sure to close all Windows applications before you start the installation.**

If you start the installation while other programs are running, a malfunction may occur. This is especially true for programs that require large amounts of system resources, such as virus-check software.

- **Be sure not to connect the Net MD to your computer before you start the installation.**

If the dedicated USB cable is connected to your computer before the installation, the installation cannot be done correctly. Connect the dedicated USB cable after the installation completed.

- **Make sure your computer has enough hard disk drive space.**

120MB of free space or more on the hard disk drive is required. If your computer does not have enough space, the installation may not be possible.

- **If the installation seems to be stopped**

It may take 30 minutes or more for the installation to complete, depending on your computer or CD-ROM drive.

During the installation, watch out for the occurrence of any of the following problems.

Problem	Cause/Remedy
The installation appears to have stopped before it has completed.	Check for the appearance of an error message beneath the installation window. → Press the [Tab] key while holding down the [Alt] key. If an error message has appeared, press the [Enter] key. The installation will resume. If there is no message, the installation is still in progress. Wait a little while longer.
The progress bar on the display is not moving. The access lamp has not lit for a few minutes.	The installation is progressing normally. Please wait.

- **If the installation is still unsuccessful after all that you have done.**

— The installation can be done by copying all files to the hard disk as follows:

- 1** Create a new folder on the hard disc.
- 2** Insert the supplied CD-ROM (SonicStage Ver.1.5) into the CD-ROM drive.
- 3** When the installation window appears, click [Exit] to cancel the installation.
- 4** Right-click the start menu and start up Explorer.
- 5** Select [SS15E] on the CD-ROM drive, and then click [Edit] -[Select All].
- 6** Click [Edit]-[Copy to Folder] (or [Edit]-[Copy]) to copy all files to the folder that you created in step 1.
- 7** Remove the CD-ROM from the CD-ROM drive, open the folder that was copied to the hard disk and double-click [setup.exe].
- 8** When the installation window appears, follow the displayed instructions to install [SonicStage 1.5].

— The installation may be done by installing the software from [Start]-[Run].

Information and explanations

Net MD FAQ

This section introduces frequently asked questions and answers on the Net MD.

On the Net MD

What is a “Net MD”?

Net MD is a specification that allows audio data in a computer to be transferred to a MiniDisc through a USB cable.

Till now, MiniDiscs could be used to record only analog sources (through a microphone or analog input) or PCM sources such as CDs. Recording audio files on a computer was impossible. However, thanks to SonicStage and other music management software based on such copyright protection technology as “OpenMG”¹⁾ and “MagicGate”²⁾, conversion of audio files to the ATRAC or ATRAC³⁾ format used on MDs became possible, enabling the recording of computer files to MDs.

- 1) Copyright protection technology for managing audio data recorded on computers, etc.
- 2) Technology for verifying the copyright-protection status of audio data in check-out/check-in operations between a computer and a Net MD device.
- 3) File type for recording to an MD.

How does the SonicStage software make using MDs more convenient?

- It allows you to record audio data from your computer to your MD.
- Editing operations are easily done using on-screen operations.
 - Labeling: Allows use of keyboard for easy labeling of contents.
 - Moving tracks or groups: Allows tracks or groups to be moved simply by dragging and dropping. Track movements are easy to see.
 - Group settings: Groups are easy to create or release.

These operations can be used to edit tracks on a disc in the Net MD. If you want to edit the contents of an MD, connect the Net MD to your computer, and edit the tracks in the SonicStage Device/Media window.

Can tracks recorded on the Net MD be checked in to a computer?

No, they cannot.

Audio data that was originally checked out from a computer can only be checked back into the same computer. Tracks that are recorded on the Net MD using a microphone or through an analog or digital connection cannot be transferred to the computer or copied.

Computer ⇔ MiniDisc : OK.

MiniDisc ⇔ Computer : OK only for tracks originally checked out from the computer.

On Editing

Can checked-out tracks be edited on the Net MD?

- Things you can do on the Net MD:
 - Label contents.
 - Assign or release groups
 - Move tracks or groups.
- Things you cannot do on the Net MD:
 - Add track marks (divide)/erase track marks (combine).
 - Delete tracks, groups, or the entire disc contents.

On copyright protection

The OpenMG technology* allows you to enjoy digital music, while maintaining the copyrights of its holders. OpenMG Jukebox encrypts audio files in OpenMG format and stores them on the hard disk of your computer to prevent unauthorized distribution.

* The copyright protection technology of this software conforms to SDMI (Secure Digital Music Initiative) specifications.

This software places some restrictions on recording and playback to protect copyrights.

You can check in audio files only to the same computer from which they were checked out.

They cannot be copied or checked in to other computers.

For details, see “Features by copyright protection by OpenMG” (page 115).

You can check-in audio files
only to the computer which
they were checked out.

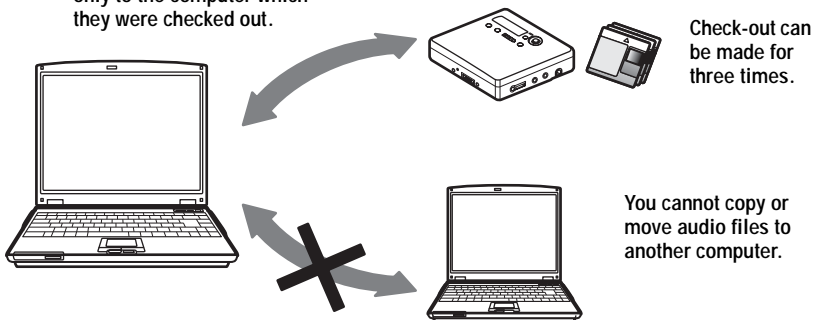

Check-out can
be made for
three times.

You cannot copy or
move audio files to
another computer.

Restrictions on audio content

High-quality digital audio content is widely available through music distribution services on the Internet. To protect the copyrights of its holders from unauthorized distribution, some audio content is distributed with certain restrictions on recording and playback. For example, the playback period or playback count for the data may be limited. In such cases, checking out of the audio contents may not be possible.

Depending on the contents, some audio data that could be checked out are subject to editing restrictions on the Net MD; e.g., audio contents cannot be erased or track marks cannot be added or erased.

It is not possible to check in tracks other than those that were checked out from your computer (for example, tracks recorded using a microphone or through analog or digital connection).

Features by copyright protection by OpenMG

The SonicStage software features OpenMG, a copyright protection technology developed by Sony to protect music copyrights. OpenMG uses high-level cryptographic technology to protect music contents with computers.

Users should be aware of the restrictions described below.

- Music recorded on the hard disk using the SonicStage software cannot be played when copied to other computers.
- Installation of the same SonicStage software to other computers is not permitted.
- Usage Rules
If Usage Rules are included in the music by way of the copyright holder or the distributor, operation will be restricted to use permitted by the Usage Rule. For music, such as compact discs, that does not contain a Usage Rule, the Default Usage Rule of SDMI will apply. This Default Usage Rule states that one file can be checked out up to three times only.
- On music contents that are not compatible with the SonicStage software
Under the supervision of SDMI, this software prohibits recording of music with a copy prohibition signal.
- Upgrading SonicStage software
This software was developed in accordance with the current arrangement between Sony and SDMI. If this arrangement is modified in the future, some of the software functions may become unavailable. Sony may offer an upgrade kit in this case at additional user expense.

Glossary

ATRAC3

ATRAC3, which stands for Adaptive Transform Acoustic Coding³, is audio compression technology that satisfies the demand for high sound quality and high compression rates. The ATRAC3 compression rate is approximately 10 times higher than that of the Audio CD, resulting in an increased data capacity for the media.

“Check-In /Check-Out”

Check-out is to transfer music files from a personal computer to an external device/media (such as a Network Walkman). Returning checked-out music files to the same computer is to check in. (You cannot move checked-out music files to another computer.)

You can check out a music file, check it back in, and then check it out again an infinite number of times. The SDMI rules provide that up to four copies of a music file can be checked out at one time. OpenMG employs a method whereby three copies of a song can be checked out simultaneously, while the fourth copy is maintained as a master on your PC.

Electronic Music Distribution (EMD) service

EMD is a website that distributes music files which are available for purchase.

MP3

MP3, which stands for MPEG-1 Audio Layer³, is a standard for audio file compression determined by the Motion Picture Experts Group, an ISO (International Organization for Standardization) working group. It enables compression of audio files to about 1/10 of the data size of a standard compact disc. Since the MP3 encoding algorithm is disclosed, there are various encoders/decoders that are compliant with this standard, including freeware that is available for no charge. The MP3 standard is therefore widely used in the computer field.

Music Drive

Music Drive is a music database for managing audio data on a computer. In Music Drive, audio files can be managed along with such information as artist names, track names, and CD jacket images, or can be combined and categorized in different playlists.

OpenMG

Copyright protection technology for the import and management of musical content from distribution services or CDs. By using software that are compliant with OpenMG, audio contents can be encrypted before storage on a hard disk drive to allow playback of those audio files on that computer. OpenMG also prevents the unauthorized distribution of the contents via the Internet or other networks.

Playlist

A playlist is like a container that can be used to hold and categorize files stored in Music Drive. For example, by making a “jazz” playlist and then putting your favorite jazz tracks into the playlist, you can play all of the tracks repeatedly or check them all out at the same time.

Recording mode (Bit rate)

This is a measure of data volume per second. The rate is expressed in bps (bits per second). In SonicStage, the bit rate can be selected for recording an audio CD or converting MP3 and WAV format audio files into ATRAC3 format from among three rates: 132 kbps, 105 kbps or 66 kbps. In the case of 105 kbps, 105,000 bits of information is processed per second. If the bit rate is large, that means a large amount of information is used to play the music. Thus, 105 kbps data produces better sound quality than 66 kbps data, and 132 kbps data provides better sound quality than 105 kbps data. However, audio files in formats such as MP3 have different encoding methods, and so the sound quality is not determined by the bit rate alone.

SDMI

SDMI, which stands for Secure Digital Music Initiative, is a forum that consists of over 130 companies in the fields of recorded audio content, computers, and consumer electronics. It is dedicated to the development of integrated copyright protection technology that can be used worldwide.

SDMI is working to create a framework for preventing the improper usage of audio files and to promote legal music distribution services. The copyright protection technology OpenMG is based on the SDMI standard.

Windows Media Audio

This is an audio compression technology that includes the management system called “Windows Media Rights Manager”.

Windows Media Technology

This is a technology that includes a contents management system called Windows Media Rights Manager which encrypts contents and distributes music contents along with their conditions for usage, distribution, etc. Audio files supporting Windows Media Technologies (WMT) downloaded via EMD* can be imported into and managed by OpenMG Jukebox.

* EMD may not be available in certain areas of the world.

Index

A

Accessories

- optional 71
- supplied 13

ATRAC3 112, 116

Audio CD 84, 93

Auto Time Mark 33

AVLS 59

B

back up 105

Bookmark

- add 37, 57
- play 37

C

CD-ROM 87

Charging 19

Check-in 112, 116

Checking

- playing position 36
- remaining time 29, 36

Check-out 96, 112, 116

Cleaning 69

Combining tracks 43

Connecting 91

- analog 32
- digital 23
- when charging 19

copyright protection 114

D

delete (software) 106

Device/Media 96, 101

DIGITAL SOUND PRESET 38

Divide

- directly 43
- rehearsal 43

DSP TYPE-S 82

E

EMD services 116

Erasing

- a whole disc 45
- groups 52
- tracks 44

G

G-PROTECTION 82

Group

- erasing 52
- moving 51
- play 47
- recording 46
- releasing 49
- setting 48
- skip 47, 57

Group Program Play 48

H

hard disk

- free space 87, 105
- storing 93

I

Installing 89

L

Labeling

- a disc 40
- tracks 40

labeling 95

M

Manual recording 34

MDLP 31

Menus 63

Move

- groups 50
- tracks 42

MP3 116

Music Drive 93, 116

N

Name

- a disc 40
- groups 50
- tracks 40

Net MD 82, 85, 112

Net MD driver 110

No sound 82

O

Online help 100

OpenMG 116

OpenMG Jukebox software 88, 104

P

- Play mode
 - groups 47
 - tracks 36, 38
- Playlist 96, 116
- Presetting radio stations
 - automatic 65
 - manual 65

Q

- Quick mode 58

R

- Radio 65
- Recording
 - adding track marks 33
 - analog 32
 - digital 22
 - level 34
 - MDLP mode 31
 - without overwriting tracks 56
- Recording mode (Bit rate) 94, 97, 117
- Recording navigation window 93
- Relabeling 41

S

- SDMI 117
- SonicStage Premium 88, 104
- SonicStage software (earlier version) 88, 104
- start (software) 92
- Synchro-recording 30
- System environment 87
- System limitations 87

T

- Track mark
 - Add (Divide) 42
 - Erase (Combine) 43
- Transferring
 - to the computer 92
 - to the Net MD 96

U

- Uninstalling
 - Windows 2000 107
 - Windows 98 Second Edition 106
 - Windows Millennium Edition 106
 - Windows XP 106

USB

- cable 13

W

- Windows 2000 107
- Windows 98 Second Edition 106
- Windows Millennium Edition 106
- Windows XP 106
- WMA 117
- WMT 117

This warranty is valid only in Canada.

SONY[®]

Portable Memory Stick Audio Player
Portable IC Audio Player
Portable MiniDisc Recorder

LIMITED WARRANTY

Sony of Canada ("Sony") warrants this Product (including any accessories) against defects in material or workmanship as follows:

- 1. LABOUR:** For a period of 90 days from the date of purchase, if this Product is determined to be defective, Sony will repair or replace the Product, at its option, at no charge, or pay the labour charges to any Sony authorized service facility. After the Warranty Period, you must pay for all labour charges.
- 2. PARTS:** In addition, Sony will supply, at no charge, new or rebuilt replacements in exchange for defective parts for a period of one (1) year. After 90 days from the date of purchase, labour for removal and installation is available from Sony authorized service facilities or a Sony Service Centre at your expense.

You can extend the warranty period for an additional nine months by registering your product (www.sonystyle.ca). Once you register your product, the limited warranty period is twelve months from the original date of purchase from Sony or a Sony authorized dealer. The ninety (90) day warranty period is extend-able only to the original purchaser, for an additional period of nine (9) months, for a total of twelve (12) months from the date of purchase when the Product is registered electronically. After the applicable period you must pay for all parts and labour charges.

To obtain warranty service, you must take the Product, or deliver the Product freight prepaid, in either its original packaging or packaging affording an equal degree of protection, to any authorized Sony service facility.

This warranty does not cover customer instruction, installation, set up adjustments or signal reception problems.

This warranty does not cover cosmetic damage or damage due to acts of God, accident, misuse, abuse, negligence, commercial use, or modification of, or to any part of the Product, including the antenna. This warranty does not cover damage due to improper operation or maintenance, connection to improper voltage supply, or attempted repair by anyone other than a facility authorized by Sony to service the Product. This warranty does not cover Products sold AS IS or WITH ALL FAULTS, or consumables (such as fuses or batteries). This warranty is valid only in Canada.

Proof of purchase in the form of a bill of sale or receipted invoice which is evidence that the unit is within the Warranty period must be presented to obtain warranty service.

This warranty is invalid if the factory-applied serial number has been altered or removed from the Product.

REPAIR OR REPLACEMENT AS PROVIDED UNDER THIS WARRANTY IS THE EXCLUSIVE REMEDY OF THE CONSUMER. SONY SHALL NOT BE LIABLE FOR ANY INCIDENTAL OR CONSEQUENTIAL DAMAGES FOR THE BREACH OF ANY EXPRESS OR IMPLIED WARRANTY ON THIS PRODUCT, EXCEPT TO THE EXTENT PROHIBITED BY APPLICABLE LAW. ANY IMPLIED WARRANTY OF MERCHANTABILITY OR FITNESS FOR A PARTICULAR PURPOSE ON THIS PRODUCT IS LIMITED IN DURATION TO THE DURATION OF THIS WARRANTY.

Some provinces do not allow the exclusion or limitation of incidental or consequential damages, or allow limitations on how long an implied warranty lasts, so the above limitations or exclusions may not apply to you. This warranty gives you specific legal rights, and you may have other rights which vary from province to province.

For your convenience, Sony of Canada Ltd. has established telephone numbers for frequently asked questions:

To locate the service or dealer nearest you, or for service assistance or resolution of a service problem, or for product information or operation, call:

Sony Customer Information Center

1 (877) 770-7669

or write to:

Sony of Canada Ltd.

115 Gordon Baker Road, Toronto, Ontario M2H 3R6 CANADA

or visit:

www.sonystyle.ca/productregistration

Portable Audio

This information is used to process your warranty registration and for after-sales support purposes. It may also be used by Sony of Canada Ltd. and affiliated Sony companies for customer relationship development and analysis, and to provide you with information and promotional offers on other products and services that may be of interest to you. For a copy of our Privacy Code, please visit our website at www.sonystyle.ca/privacy or call 1-877-899-7669.

This warranty is valid only in the United States.

SONY[®]

Portable Memory Stick Audio Player/
Portable MiniDisc Recorder/
Portable CD Player

LIMITED WARRANTY

Portable Audio

Sony Electronics Inc. ("Sony") warrants this Product (including any accessories) against defects in material or workmanship as follows:

1. **LABOR:** For a period of 90 days from the date of purchase, if this Product is determined to be defective, Sony will repair or replace the Product, at its option, at no charge, or pay the labor charges to any Sony authorized service facility. After the Warranty Period, you must pay for all labor charges.

2. **PARTS:** In addition, Sony will supply, at no charge, new or rebuilt replacements in exchange for defective parts for a period of one (1) year. After 90 days from the date of purchase, labor for removal and installation is available from Sony authorized service facilities or a Sony Service Center at your expense.

To obtain warranty service, you must take the Product, or deliver the Product freight prepaid, in either its original packaging or packaging affording an equal degree of protection, to any authorized Sony service facility.

This warranty does not cover customer instruction, installation, set up adjustments or signal reception problems.

This warranty does not cover cosmetic damage or damage due to acts of God, accident, misuse, abuse, negligence, commercial use, or modification of, or to any part of the Product, including the antenna. This warranty does not cover damage due to improper operation or maintenance, connection to improper voltage supply, or attempted repair by anyone other than a facility authorized by Sony to service the Product. This warranty does not cover Products sold AS IS or WITH ALL FAULTS, or consumables (such as fuses or batteries). This warranty is valid only in the United States.

Proof of purchase in the form of a bill of sale or receipted invoice which is evidence that the unit is within the Warranty period must be presented to obtain warranty service.

This warranty is invalid if the factory applied serial number has been altered or removed from the Product.

REPAIR OR REPLACEMENT AS PROVIDED UNDER THIS WARRANTY IS THE EXCLUSIVE REMEDY OF THE CONSUMER. SONY SHALL NOT BE LIABLE FOR ANY INCIDENTAL OR CONSEQUENTIAL DAMAGES FOR BREACH OF ANY EXPRESS OR IMPLIED WARRANTY ON THIS PRODUCT, EXCEPT TO THE EXTENT PROHIBITED BY APPLICABLE LAW, ANY IMPLIED WARRANTY OF MERCHANTABILITY OR FITNESS FOR A PARTICULAR PURPOSE ON THIS PRODUCT IS LIMITED IN DURATION TO THE DURATION OF THIS WARRANTY.

Some states do not allow the exclusion or limitation of incidental or consequential damages, or allow limitations on how long an implied warranty lasts, so the above limitations or exclusions may not apply to you. In addition, if you enter into a service contract with the Sony Partnership within 90 days of the date of sale, the limitation on how long an implied warranty lasts does not apply to you. This warranty gives you specific legal rights, and you may have other rights which vary from state to state.

For your convenience, Sony Electronics Inc. has established telephone numbers for frequently asked questions:

To locate the servicer or dealer nearest you, or for service assistance or resolution of a service problem, or for product information or operation, contact:

www.sony.com/walkmansupport

Sony Network Portable Audio Support Line
1-(866)-456-7669

Sony Customer Information Service Center
12451 Gateway Blvd.
Fort Myers, FL 33913

For an accessory or part not available from your authorized dealer, call:

1-(800)-488-SONY (7669)

D 324343302

<http://www.sony.net/>

Printed in Malaysia



Printed using VOC (Volatile Organic Compound)-free vegetable oil ink.