

MiniDisc Recorder MD-105X

Operating Instructions

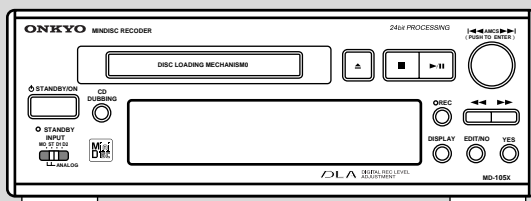

Before using

Connections

Operations

Other Information

Before using

Thank you for purchasing ...

Thank you for purchasing the ONKYO MD-105X MD Recorder.

Please read this manual thoroughly before making connections and plugging in the unit.

Following the instructions in this manual will enable you to obtain the optimum performance and listening enjoyment from your new MD-105X.

Please retain this manual for future reference.

Main Features

- 24-Bit A/D and D/A Converters
- Digital Rec Level Adjustment
- Rec Volume Control for Analog and Digital Inputs
- Album Dubbing and Fade Out Control
- Unique "Dub It" Feature
- Monaural Recording
- One-Touch Dubbing
- Signal Synchro Recording

Memory Preservation

This unit does not require memory preservation batteries. A built-in memory power back-up system preserves the contents of the memory during power failures and even when the unit is unplugged. The unit must be plugged-in in order to charge the back-up system.

The memory preservation period after the unit has been unplugged varies depending on climate and placement of the unit. On the average, memory contents are protected over a period of a few weeks after the last time the unit was unplugged. This period is shorter when the unit is exposed to a highly humid climate.

Declaration of Conformity

We, ONKYO EUROPE
ELECTRONICS GmbH
INDUSTRIESTRASSE 20
82110 GERMERING,
GERMANY



declare in own responsibility, that the ONKYO product described in this instruction manual is in compliance with the corresponding technical standards such as EN60065, EN55013, EN55020 and EN61000-3-2, -3-3 (or EN60555-2, -3)

GERMERING, GERMANY

K.OTSU

ONKYO EUROPE ELECTRONICS GmbH

U.S. and foreign patents licensed from Dolby Laboratories Licensing Corporation.

WARNING:

TO REDUCE THE RISK OF FIRE OR ELECTRIC SHOCK, DO NOT EXPOSE THIS APPLIANCE TO RAIN OR MOISTURE.



WARNING
RISK OF ELECTRIC SHOCK
DO NOT OPEN

AVIS
RISQUE DE CHOC ELECTRIQUE
NE PAS OUVRIR



CAUTION:

TO REDUCE THE RISK OF ELECTRIC SHOCK, DO NOT REMOVE COVER (OR BACK). NO USER-SERVICEABLE PARTS INSIDE. REFER SERVICING TO QUALIFIED SERVICE PERSONNEL.



The lightning flash with arrowhead symbol, within an equilateral triangle, is intended to alert the user to the presence of uninsulated "dangerous voltage" within the product's enclosure that may be of sufficient magnitude to constitute a risk of electric shock to persons.

The exclamation point within an equilateral triangle is intended to alert the user to the presence of important operating and maintenance (servicing) instructions in the literature accompanying the appliance.

Important Safeguards

1. **Read Instructions** – All the safety and operating instructions should be read before the appliance is operated.
2. **Retain Instructions** – The safety and operating instructions should be retained for future reference.
3. **Heed Warnings** – All warnings on the appliance and in the operating instructions should be adhered to.
4. **Follow Instructions** – All operating and use instructions should be followed.
5. **Water and Moisture** – The appliance should not be used near water – for example, near a bathtub, washbowl, kitchen sink, laundry tub, in a wet basement, or near a swimming pool, and the like.
6. **Carts and Stands** – The appliance should be used only with a cart or stand that is recommended by the manufacturer.
- 6A. An appliance and cart combination should be moved with care. Quick stops, excessive force, and uneven surfaces may cause the appliance and cart combination to overturn.

PORTABLE CART WARNING
S3125A
7. **Wall or Ceiling Mounting** – The appliance should be mounted to a wall or ceiling only as recommended by the manufacturer.
8. **Ventilation** – The appliance should be situated so that its location or position does not interfere with its proper ventilation. For example, the appliance should not be situated on a bed, sofa, rug, or similar surface that may block the ventilation openings; or if placed in a built-in installation, such as a bookcase or cabinet that may impede the flow of air through the ventilation openings, there should be free space of at least 5 cm (2 in.) and an opening behind the appliance.
9. **Heat** – The appliance should be situated away from heat sources such as radiators, heat registers, stoves, or other appliances (including amplifiers) that produce heat.
10. **Power Sources** – The appliance should be connected to a power supply only of the type described in the operating instructions or as marked on the appliance.
11. **Polarization** – If the appliance is provided with a polarized plug having one blade wider than the other, please read the following information: The polarization of the plug is a safety feature. The polarized plug will only fit the outlet one way. If the plug does not fit fully into the outlet, try reversing it. If there is still trouble, the user should seek the services of a qualified electrician. Under no circumstances should the user attempt to defeat the polarization of the plug.
12. **Power-Cord Protection** – Power-supply cords should be routed so that they are not likely to be walked on or pinched by items placed upon or against them, especially near plugs, convenience receptacles, and the point where they exit from the appliance.
13. **Cleaning** – The appliance should be cleaned only as recommended by the manufacturer.
14. **Nonuse Periods** – The power cord of the appliance should be unplugged from the outlet when left unused for a long period of time.
15. **Object and Liquid Entry** – Care should be taken so that objects do not fall and liquids are not spilled into the enclosure through openings.
16. **Damage Requiring Service** – The appliance should be serviced by qualified service personnel when:
 - A. The power-supply cord or the plug has been damaged; or
 - B. Objects have fallen, or liquid has been spilled into the appliance; or
 - C. The appliance has been exposed to rain; or
 - D. The appliance does not appear to operate normally or exhibits a marked change in performance; or
 - E. The appliance has been dropped, or the enclosure damaged.
17. **Servicing** – The user should not attempt to service the appliance beyond that described in the operating instructions. All other servicing should be referred to qualified service personnel.

Precautions

1. Warranty Claim

You can find the serial number on the rear panel of this unit. In case of warranty claim, please report this number.

2. Recording Copyright

Recording of copyrighted material for other than personal use is illegal without permission of the copyright holder.

3. Power

WARNING

BEFORE PLUGGING IN THE UNIT FOR THE FIRST TIME, READ THE FOLLOWING SECTION CAREFULLY.

The voltage of the available power supply differs according to country or region. Be sure that the power supply voltage of the area where this unit will be used meets the required voltage (e.g., AC 230 V, 50 Hz or AC 120 V, 60 Hz) written on the rear panel.

Turning off the standby button does not shut off the power completely. So the power cord should be removed from the AC outlet when the unit is not used for a prolonged time.

4. Do not touch this unit with wet hands

Do not handle this unit or power cord when your hands are wet or damp. If water or any other liquid enters the case, take this unit to an authorized service center for inspection.

5. Location of this unit

Place this unit in a well-ventilated location.

Take special care to provide plenty of ventilation on all sides of this unit especially when it is placed in an audio rack. If ventilation is blocked, this unit may overheat and malfunction.

Do not expose this unit to direct sunlight or heating units as this unit's internal temperature may rise and shorten the life of the pickup.

Avoid damp and dusty places and places directly affected by vibrations from the speakers. In particular, avoid placing the unit on or above one of the speakers.

Be sure this unit is placed in a horizontal position. Never place it on its side or on a slanted surface as it may malfunction.

Do not place near tuners or TV sets.

If placed next to a TV or tuner, it may cause reception interference resulting in some noise in the TV or tuner output.

6. Care

From time to time you should wipe the front and rear panels and the cabinet with a soft cloth. For heavier dirt, dampen a soft cloth in a weak solution of mild detergent and water, wring it out dry, and wipe off the dirt. Following this, dry immediately with a clean cloth.

Do not use rough material, thinners, alcohol or other chemical solvents or cloths since these could damage the finish or remove the panel lettering.

7. Points to remember

If this unit is brought from a cold environment to a warm one or is in a cold room that is quickly heated, condensation may form on the pickup, preventing proper operation. In this case, remove the disc and leave the power ON for about one hour to remove the condensation.

When transporting this unit, be careful not to bump it.

DANGER:

INVISIBLE LASER RADIATION WHEN OPEN AND INTERLOCK FAILED OR DEFEATED. AVOID DIRECT EXPOSURE TO BEAM.

CAUTION:

THIS PRODUCT UTILIZES A LASER. USE OF CONTROLS OR ADJUSTMENTS OR PERFORMANCE OF PROCEDURES OTHER THAN THOSE SPECIFIED HEREIN MAY RESULT IN HAZARDOUS RADIATION EXPOSURE.

Precautions(continued)

For U.S. model

The laser is covered by a housing which prevents exposure during operation or maintenance. However, this product is classified as a Laser Product by CDRH (Center for Devices and Radiological Health) which is a department of the Food and Drug Administration. According to their regulations 21 CFR section 1002.30, all manufacturers who sell Laser Products must maintain records of written communications between the manufacturer, dealers and customers concerning radiation safety. If you have any complaints about instructions or explanations affecting the use of this product, please feel free to write to the address on the back page of this manual. When you write us, please include the model number and serial number of your unit.

In compliance with Federal Regulations, the certification, identification and the period of manufacture are indicated on the rear panel.

FCC INFORMATION FOR USER

CAUTION:

The user changes or modifications not expressly approved by the party responsible for compliance could void the user's authority to operate the equipment.

NOTE:

This equipment has been tested and found to comply with the limits for a Class B digital device, pursuant to Part 15 of the FCC Rules. These limits are designed to provide reasonable protection against harmful interference in a residential installation. This equipment generates, uses and can radiate radio frequency energy and, if not installed and used in accordance with the instructions, may cause harmful interference to radio communications. However, there is no guarantee that interference will not occur in a particular installation. If this equipment does cause harmful interference to radio or television reception, which can be determined by turning the equipment off and on, the user is encouraged to try to correct the interference by one or more of the following measures:

- Increase the separation between the equipment and receiver.
- Connect the equipment into an outlet on a circuit different from that to which the receiver is connected.
- Consult the dealer or an experienced radio/TV technician for help.

Precautions(continued)

For Canadian model

CAUTION: THIS DIGITAL APPARATUS DOES NOT EXCEED THE CLASS B LIMITS FOR RADIO NOISE EMISSION FROM DIGITAL APPARATUS SET OUT IN THE RADIO INTERFERENCE REGULATIONS OF THE CANADIAN DEPARTMENT OF COMMUNICATIONS.

For models having a power cord with a polarized plug:

CAUTION: TO PREVENT ELECTRIC SHOCK, MATCH WIDE BLADE OF PLUG TO WIDE SLOT, FULLY INSERT.

Modele pour les Canadien

ATTENTION: L'INTERFÉRENCE RADIO ÉLECTRIQUE GÉNÉRÉE PAR CET APPAREIL NUMÉRIQUE DE TYPE B NE DÉPASSE PAS LES LIMITES ÉNONCÉES DANS LE RÈGLEMENT SUR LES PERTURBATIONS RADIO ÉLECTRIQUES, SECTION APPAREIL NUMÉRIQUE, DU MINISTÈRE DES COMMUNICATIONS.

Sur les modèles dont la fiche est polarisée:

ATTENTION: POUR ÉVITER LES CHOCS ÉLECTRIQUES, INTRODUIRE LA LAME LA PLUS LARGE DE LA FICHE DANS LA BORNE CORRESPONDANTE DE LA PRISE ET POUSSER JUSQU'AU FOND.

For European model

This unit contains a semiconductor laser system and is classified as a "CLASS 1 LASER PRODUCT". So, to use this model properly, read this Instruction Manual carefully. In case of any trouble, please contact the store where you purchased the unit. To prevent being exposed to the laser beam, do not try to open the enclosure.



This label on the left hand panel states that:

1. This unit is a CLASS 1 LASER PRODUCT and employs a laser inside the cabinet.
2. To prevent the laser from being exposed, do not remove the cover. Refer servicing to qualified personnel.

For British model

Replacement and mounting of an AC plug on the power supply cord of this unit should be performed only by qualified service personnel.

IMPORTANT

The wires in the mains lead are coloured in accordance with the following code:

Blue : Neutral

Brown : Live

As the colours of the wires in the mains lead of this apparatus may not correspond with the coloured markings identifying the terminals in your plug, proceed as follows:

The wire which is coloured blue must be connected to the terminal which is marked with the letter N or coloured black.

The wire which is coloured brown must be connected to the terminal which is marked with the letter L or coloured red.

IMPORTANT

A 5 amp fuse is fitted in this plug. Should the fuse need to be replaced, please ensure that the replacement fuse has a rating of 5 amps and that it is approved by ASTA or BSI to BS1362. Check for the ASTA mark or the BSI mark on the body of the fuse.

IF THE FITTED MOULDED PLUG IS UNSUITABLE FOR THE SOCKET OUTLET IN YOUR HOME, THEN THE FUSE SHOULD BE REMOVED AND THE PLUG CUT OFF AND DISPOSED OF SAFELY. THERE IS A DANGER OF SEVERE ELECTRICAL SHOCK IF THE CUT OFF PLUG IS INSERTED INTO ANY 13 AMP SOCKET.

If in any doubt, please consult a qualified electrician.

Table of contents

Before Using

Checking the supplied accessories	Below
Using the remote controller	8

Connections

Connecting to the Onkyo Separate Collection series components	9
Connecting to the other components	10

Operations

Normal play	14
Random play	18
Repeat play	19
Memory play	21
CD-dubbing	23
Analog recording	25
Digital recording	28
Signal Synchro recording	31
System operation	32
Other information for recording	36
Editing the contents of an MD	37
Naming a track or disc	42
Canceling the last editing	45

Other Information

Message list	46
System limitations	47
Rules for digital recording	48
Troubleshooting	49
Precautions for handling the MiniDisc (MD)	51
Indexed to parts and controls	52
Specifications	56

Checking the supplied accessories

Check that the following accessories are supplied with this unit.

- **RI remote control cable x1**
- **Audio connection cable x2**
- **Optical fiber cable x1**

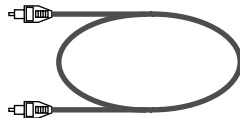
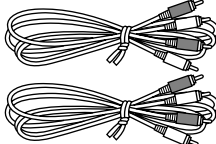

- **Remote controller x1**
RC-409MD

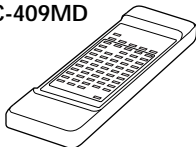

- **Dry batteries UM-3 x2**



Using the remote controller

Inserting the remote controller batteries

- 1 Remove the battery compartment cover by opening it as shown in the illustration.**

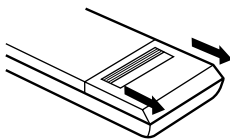

- 2 Insert two AA (R6 or UM-3)-size batteries into the battery compartment.**

Carefully follow the polarity diagram (positive(+)) and negative (-) symbols inside the battery compartment.

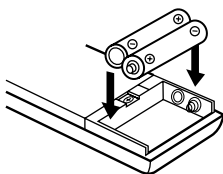

- 3 Replace the compartment cover.**

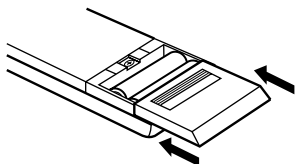

Notes

- Do not mix new batteries with old batteries or different kinds of batteries.
- To avoid corrosion, remove the batteries if the remote controller is not to be used for a long time.
- Remove dead batteries immediately to avoid damage from corrosion. If the remote controller doesn't operate smoothly, replace both the batteries at the same time.
- The life of the batteries supplied is about six months but this will vary depending on usage.

Using the remote controller

Point the remote controller toward the remote control sensor.

With the supplied remote controller (RC-409MD)

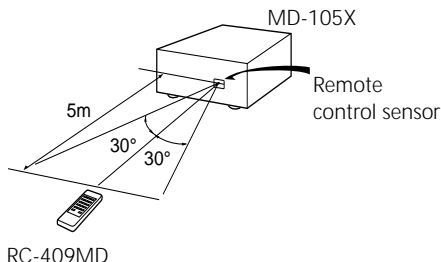

Point the remote controller toward MD-105X's remote control sensor.

- Place the unit away from strong light such as direct sunlight or inverted fluorescent light which can prevent proper operation of the remote controller.
- Using another remote controller of the same type in the same room or using the unit near equipment which uses infrared rays may cause operational interference.
- Do not put any object such as a book on the remote controller. The buttons of the remote controller may be pressed by mistake and drain the batteries.
- Make sure the audio rack doors do not have colored glass. Placing the unit behind such doors may prevent proper remote controller operation.
- If there is any obstacle between the remote controller and the remote control sensor, the remote controller will not operate.

Using the remote controller(continued)

Inserting the remote controller batteries

- 1 Remove the battery compartment cover by pressing the tab and lifting up the cover.**

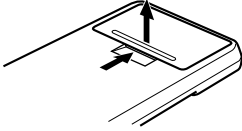

- 2 Insert two AA (R6 or UM-3)-size batteries into the battery compartment.**

Carefully follow the polarity diagram (positive(+)) and negative (-) symbols inside the battery compartment.

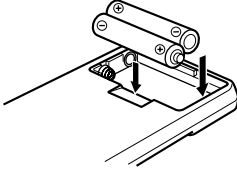

- 3 Replace the compartment cover.**

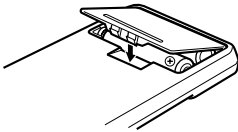

Notes

- Do not mix new batteries with old batteries or different kinds of batteries.
- To avoid corrosion, remove the batteries if the remote controller is not to be used for a long time.
- Remove dead batteries immediately to avoid damage from corrosion. If the remote controller doesn't operate smoothly, replace both the batteries at the same time.
- The life of the batteries supplied is about six months but this will vary depending on usage.

Using the remote controller

Point the remote controller toward the remote control sensor.

With RC-398S
(supplied with A-905X amplifier)

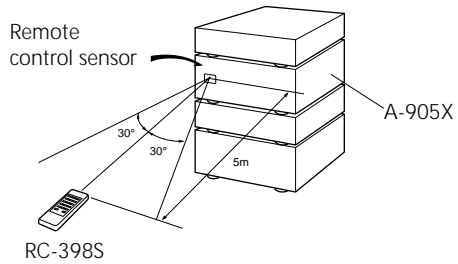

Point the remote controller toward A-905X's remote control sensor.

- Place the unit away from strong light such as direct sunlight or inverted fluorescent light which can prevent proper operation of the remote controller.
- Using another remote controller of the same type in the same room or using the unit near equipment which uses infrared rays may cause operational interference.
- Do not put any object such as a book on the remote controller. The buttons of the remote controller may be pressed by mistake and drain the batteries.
- Make sure the audio rack doors do not have colored glass. Placing the unit behind such doors may prevent proper remote controller operation.
- If there is any obstacle between the remote controller and the remote control sensor, the remote controller will not operate.

Connecting to the Onkyo Separate Collection series components

This section introduces you to the other Separate Collection Series system components and their convenient system functions, followed by connecting instructions.

The following Separate Collection series components are commercially available:

- T-405X Stereo Tuner
- A-905X Integrated Stereo Amplifier
- K-505X Stereo Cassette Tape Deck
- C-705X Compact Disc (CD) Player (Not available in U.S.A and Canada)
- C-707CH Compact Disc (CD) Changer (Only available in U.S.A. and Canada)

Note that the available components may vary according to the area.

Combination use of the unit with the above system components enables you to operate the following convenient functions.

• **Auto Power On**

- You can turn on the power to the amplifier by pressing the STANDBY/ON button on one of the system components. (The amplifier's POWER switch must be set to ON.)
- When the amplifier's POWER switch is set to ON, you can turn on the power to all the system components simultaneously by pressing the STANDBY/ON button the amplifier. Afterwards, you can turn off the power to the individual components that are not in use.

• **Direct Change**

Pressing the ►/|| button of the MD-105X automatically selects the "MD" input source on the A-905X before playing the MD.

• **Remote control of the System Components**

You can control the operation of this MD recorder using the A-905X's remote controller.

• **Program Timer**

You can record the desired broadcasting programs or play your favorite MD at a specified time using the T-405X's built-in timer. (Refer to the T-405X instruction manual for details.)

• **Sleep Timer**

You can fall asleep to a music/radio program with the timer. (Refer to the T-405X instruction manual for details.)

• **CD-dubbing**

You can start recording from a CD player to your MD-105X by pressing the CD DUBBING button.

• **CD-synchro Recording**

When this function is enabled, you can immediately start recording to the MD by pressing the ► button on the CD player. (Refer to page 32 for details.)

• **Cassette-synchro Recording**

When this function is enabled, you can start recording to the MD by pressing the ► button on the cassette deck. (Refer to page 33 for details.)

Connecting to the other components

Before connecting

- Do not connect the unit's AC power cord to a wall outlet until you have completed all the other connections.
- On each pair of connectors, a red connector (marked R) corresponds to the right channel, and a white connector (marked L) to the left channel. Connect white plugs of audio connection cables to L connectors and connect red plugs of audio connection cables to R connectors.

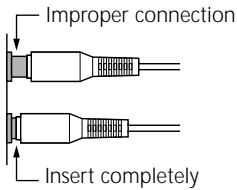
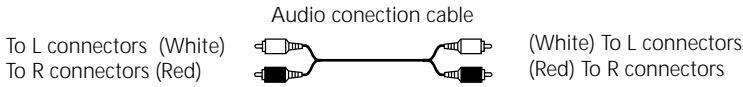

- Insert the plug securely. If the connection is incomplete, noise or malfunction may result.
- When you use a digital audio optical cable, do not bend it sharply nor coil it tightly.
- Bundling an audio connection cable with the power cord or speaker cord may degrade the sound quality.
- To use the unit with the other Onkyo Separate Collection series components, follow the connection diagram in the A-905X instruction manual to connect the unit to the system.

Note:

The 230 V model is show in the following illustrations.

Connecting to the other components

- This unit use heat-sensitive parts. Do not place this unit on the Amplifier or Receiver.

Connections

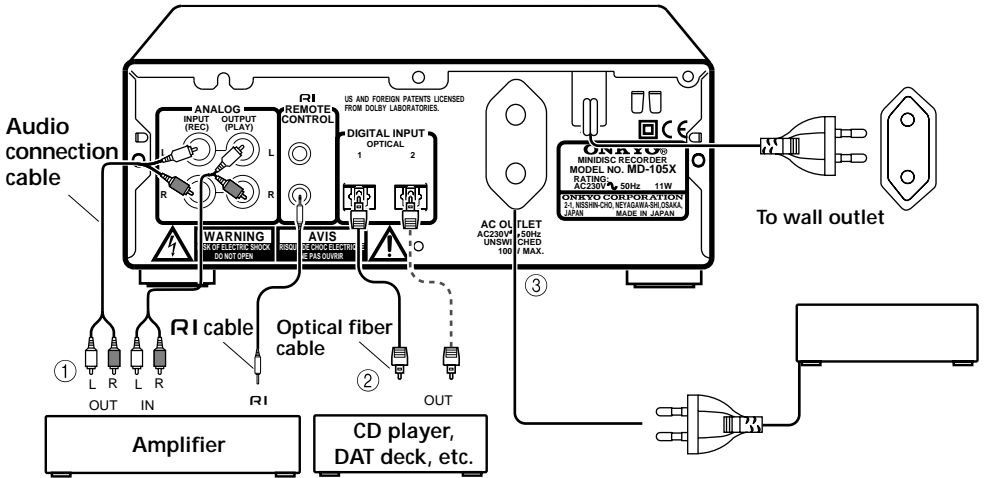

① Connection with the Amplifier

Connect the MD-105X to the MD (or TAPE) jacks of your amplifier.

② Connection to the Digital Input

Terminals (DIGITAL INPUT 1, 2)

You can perform digital recording on the MD-105X if a CD (Compact Disc) player or DAT (Digital Audio Tapedeck) equipped with a digital (OPTICAL) output terminal is available. For digital recording, you need to connect the equipment to either DIGITAL INPUT 1 or 2 terminal using the supplied optical cable. These terminals can also be used for connecting an amplifier which is equipped with a digital output terminal.

- Terminal protection caps are attached to the DIGITAL INPUT terminals. Remove the cap for the terminal you wish to use when connecting the MD-105X to digital equipment. Replace the caps if you are not using the DIGITAL INPUT terminals.

③ Connection to AC outlet (UNSWITCHED)

The power cord of another unit can be connected to this outlet.

Note

The shape, number, and total capacity of the AC outlets may differ depending on the area where the unit is purchased.

230 V, 50 Hz model: Capacity is 100 W in total.

120 V, 60 Hz model: Capacity is 120 W in total.

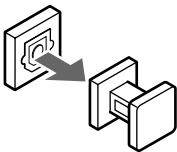

Note

- If the DIGITAL INPUT 2 is used for connecting the amplifier, you cannot use the full capability of the MD-105X.
- If you attempt to perform digital recording using a digital input terminal which is not connected, "D.In Unlock" will appear.

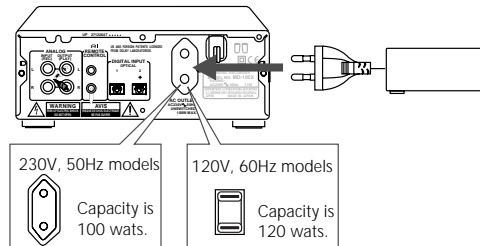

Connecting to the other components (continued)

Connecting the (R) controller

If you are using other ONKYO components equipped with **RI** connectors, you can control these components using the amplifier's remote controller.

Before connecting

- The amplifier must be connected in the **RI** system hookups for **RI** control operation.
- Each component has two **RI** connectors. There is no difference between those connectors.
- The components may be connected in any order.
- Remote control operation is not possible if only the **RI** remote control cable is connected to the **RI** connectors. Connect the audio connection cables correctly.

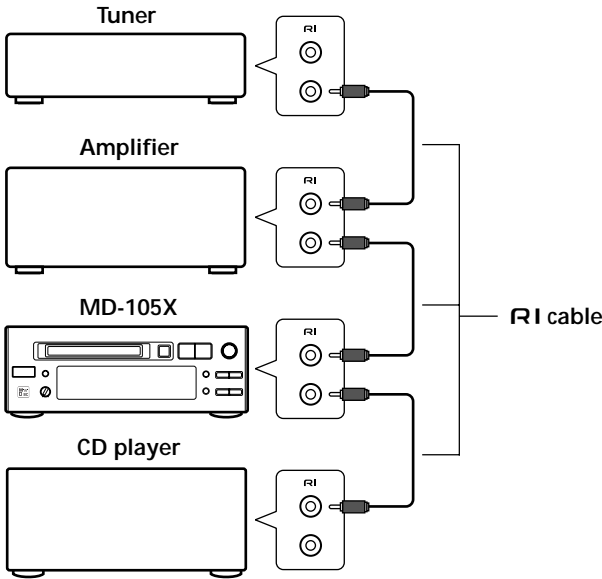

Connecting the AC power cord (mains lead)

Insert the AC power cord into a wall outlet. The **STANDBY** indicator lights.

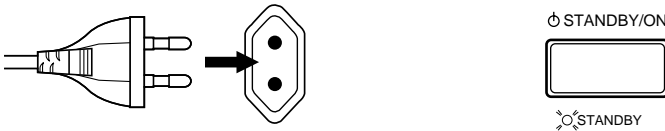

- To use the unit with the other Onkyo Separate Collection series components, follow the connection diagram in the A-905X instruction manual to connect the unit to the system.
- If you press the EJECT button while the unit is in the STANDBY mode, the power will turn on and the display will light up automatically.

Operations

Normal play

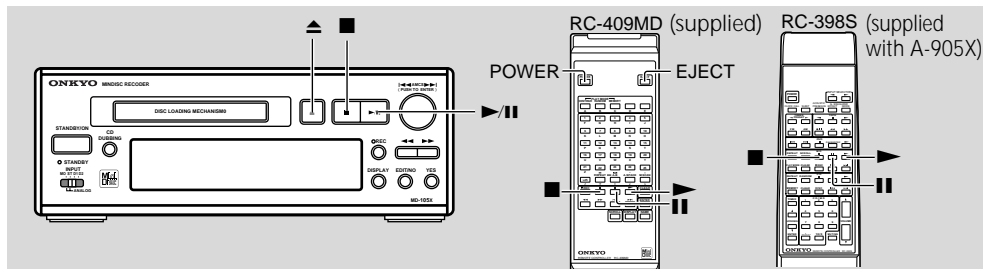

1 Press the **STANDBY/ON** button. (or the **POWER** button on the remote controller)

The **STANDBY** indicator goes out.

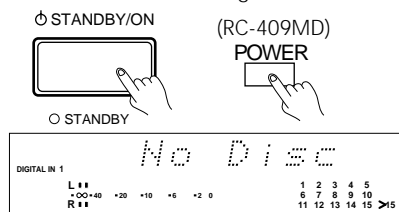

2 Insert an MD.

The MD recorder reads TOC (Table of Contents) information on the MD to display the total number of tracks and total playing time.

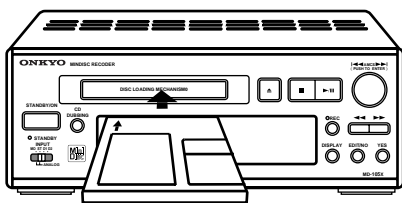

The total number of tracks

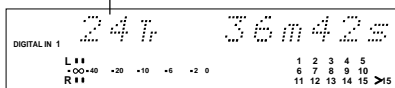

Current track number

- When an MD recorded with a disc name (title) is inserted, the disc name is displayed. If the disc name is too long and you cannot view the entire name, press the **SCROLL** button on your remote controller to shift the display.

3 Press the **▶/||** button (or the **▶** button on the remote controller).

The first track of the disc starts playing.

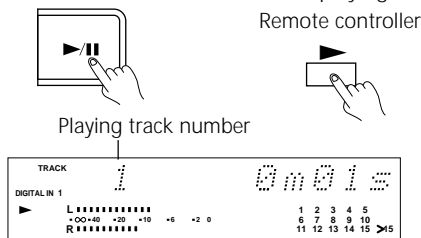

Stopping play

Press the **■** button (or the **■** button on the remote controller).

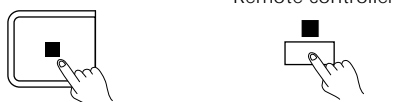

Stopping play temporarily

Press the **▶/||** button (or the **||** button on the remote controller).

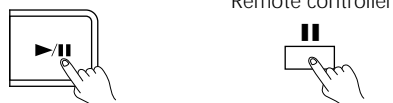

To resume play, press the **▶/||** button (or the **▶** button on the remote controller).

Ejecting the MD

Press the **▲** button. (or the **EJECT** button on the remote controller.)

The MD comes out and "EJECT" is shown on the display.

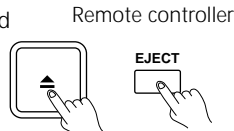

Normal play (continued)

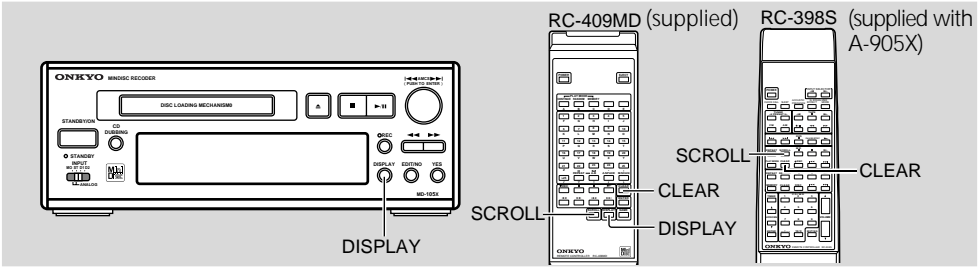

Changing the display mode

When the MD recorder is stopped
Pressing the DISPLAY button changes the display in the following sequence:

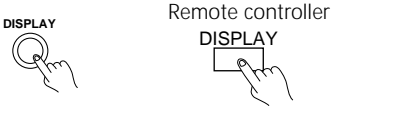

Total number of tracks on the MD and its total playing time

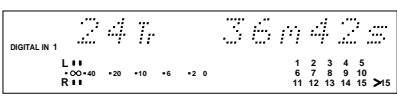

Time remaining for recording on the MD (Not displayed if it is a premastered MD)

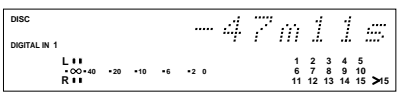

Disc name ("No Name" when not set)

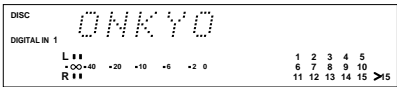

When an MD is playing
Pressing the DISPLAY button changes the display in the following sequence:

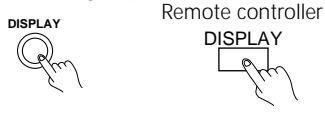

Playing track number and elapsed playing time

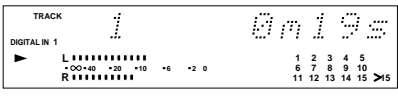

Playing track number and remaining playing time

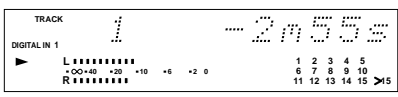

Track name (Track number with "No Name" when not set)

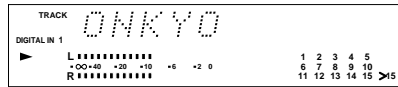

If the track name is too long to display

You can scroll the track name by pressing the SCROLL button on the remote controller. Press the SCROLL button when the track name is scrolling to stop the scrolling of the track name; press the SCROLL button again to resume the scrolling of the track name. To exit the display scroll mode, press the CLEAR button on the remote controller.

Normal play (continued)

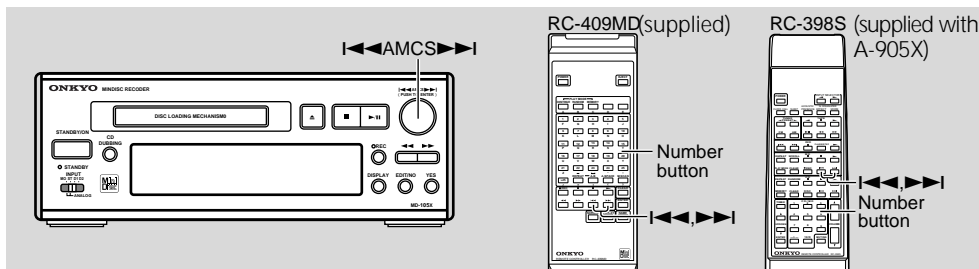

Selecting the track to play using the number buttons

Press the number button on the remote controller to select the track you want to play.

(RC-409MD)

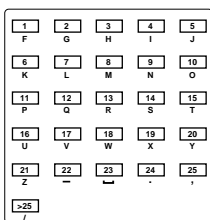

(RC-398S)

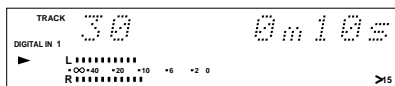
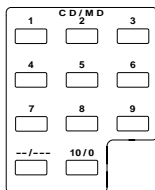

To select a track numbered 26 or above using RC-409MD

Press the [>25] button first. Set a value for the 10th place and then the 1st place using the number buttons in this order. ("0" can be entered by pressing the [10] button.)

Ex. To select the 30th track:

[>25] + [3] + [10]

To select the 100th track:

[>25] + [>25] + [1] + [10] + [10]

To select a track numbered 11 or above using RC-398S

Press the [--/--] button first. Set a value for the 10th place and then the 1st place using the number buttons in this order. ("0" can be entered by pressing the [10/0] button.)

Ex. To select the 30th track:

[--/--] + [3] + [10/0]

To select the 100th track:

[--/--] + [--/--] + [1] + [10/0] + [10/0]

Changing the playing track using the AMCS

During play, you can change the track that is playing by turning the AMCS knob (or by pressing the \lll and \ggg buttons on the remote controller).

If the MD recorder is stopped, turn the AMCS knob to select the track number you wish to play, and press that knob (with the remote controller, use the \lll or \ggg button to select the track, then press the \ggg button.)

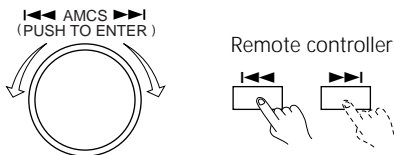

To play the next track or a later track

Turn the AMCS knob clockwise (or press the \ggg button on the remote controller several times) until the desired track is located.

To start play again from the beginning of the track that is currently playing or to play the previous track or an earlier track

Turn the AMCS knob counterclockwise (or press the \lll button on the remote controller several times) until the desired track is located. In the Memory play mode (see page 19), turning the AMCS knob (or pressing the \ggg or \lll button) selects the track in the stored sequence.

Normal play (continued)

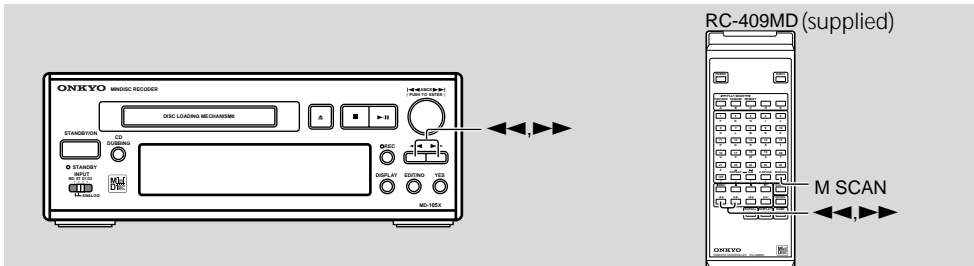

Music Scan

The following operation is possible only when using the supplied remote controller (RC-409MD).

Pressing the M.SCAN button plays the beginning (8 seconds) of each track on the disc in sequence whether the MD recorder is either playing or stopped.

- The ► indicator flashes during Music Scan.
- You can press the ► or M.SCAN button on the remote controller when the beginning of the desired track is playing to start playing from that track.

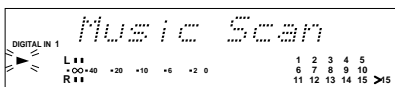

Searching for a part to play (Search play)

Searching for a part to play by sound (at play)

During play, hold down the ◀◀ or ▶▶ button and release it when the part you want to hear is playing.

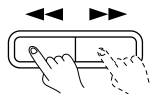

Searching for a part to play by using displayed time (at pause, high-speed search)

When playing is temporarily stopped (paused), keep pressing the ◀◀ or ▶▶ button and release it when the playing time of the part you want to hear is displayed.

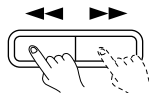

- Press the ►|| button (or the ► button on the remote controller) to start playing from that part.
- "Over" in the display indicates that the end of the last track is reached.

Random play

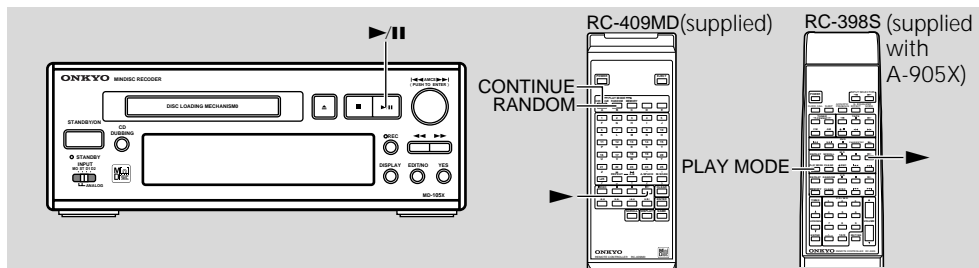

The following operation is possible only when using either of the following remote controllers:
 RC-409MD (supplied)
 RC-398S (supplied with the A-905X amplifier)

1 When the MD recorder is stopped, press the **RANDOM** button (RC-409MD).

With the RC-398S remote controller, press the **PLAY MODE** button until "RANDOM" appears on the display.

(RC-409MD) (RC-398S)

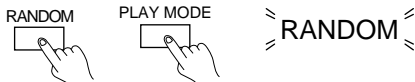

2 Press the **▶/||** button (or the **▶** button on the remote controller).

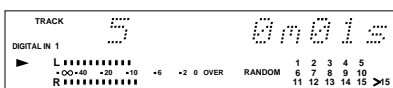

To exit the Random play mode

When the MD recorder is stopped, press the **CONTINUE** button (RC-409MD).

With the RC-398S remote controller, press the **PLAY MODE** button until "RANDOM" or "MEMORY" disappears from the display.

Repeat play

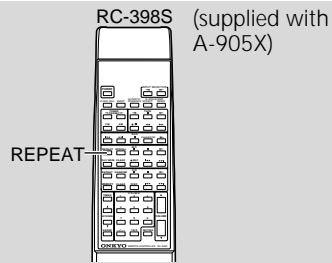
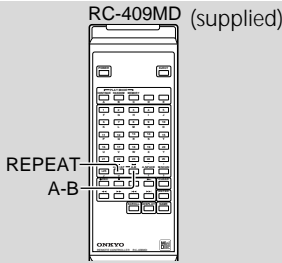

The following operation is possible using either of the following remote controllers only:
 RC-409MD (supplied)
 RC-398S (supplied with the A-905X amplifier)

The following operation is possible only when using the supplied remote controller (RC-409MD).

Repeatedly playing a section of a track (A-B Repeat)

Repeatedly playing all tracks of an MD

Press the REPEAT button on the remote controller just once.

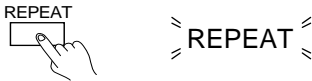

Repeatedly playing a single track

When the desired track is playing, press the REPEAT button on the remote controller twice.

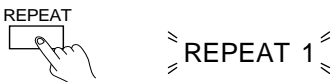

Note

In Memory play or Random play, you cannot repeat the currently playing track (REPEAT 1).

- **If the REPEAT button is pressed during Memory play...**

Only the programmed tracks will be played repeatedly in the programmed order.

- **If the REPEAT button is pressed during Random play...**

The contents of the entire MD will be played again repeatedly with the playing order changed each time a random play begins.

To stop the Repeat play

Press the REPEAT button once or twice until the "REPEAT" indicator disappears.

1 While the track is playing, specify the beginning of the section you wish to repeat playing by pressing the A-B button on the remote controller (Point A).

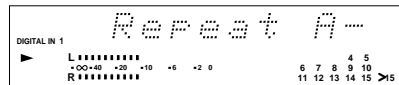

2 While the track is still playing, specify the end of the section by pressing the A-B button on the remote controller (Point B) a second time.

Section A to B of the track will be repeated.

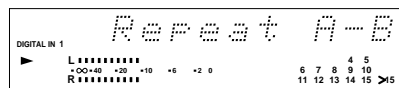

Repeat play (continued)

To stop A-B Repeat

- Press the A-B or REPEAT button when a section is in Repeat play.
The A-B Repeat mode is now canceled.
- Press the  button when a section is in Repeat play.
The A-B Repeat mode is canceled and play of the current track stops.

Note

A-B Repeat cannot be used when the unit is in Repeat (all-track or single-track), Memory, or Random play.

Memory play

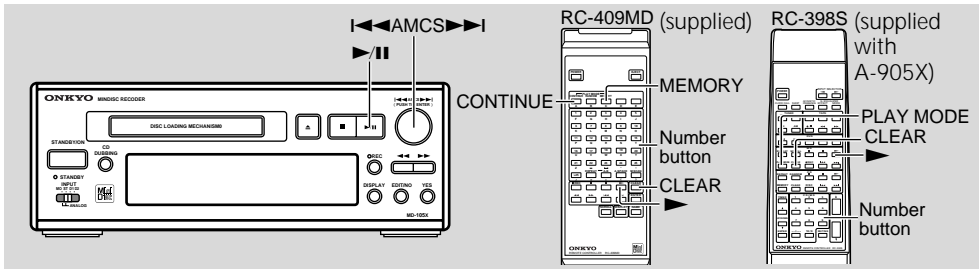

- Using the Memory function, you can select your favorite tracks (up to 25 tracks) on an MD and arrange them in the desired order.

1 When the MD recorder is stopped, press the MEMORY button (RC-409MD).

With the RC-398S remote controller, press the PLAY MODE button until "MEMORY" appears on the display.

(RC-409MD) (RC-398S)

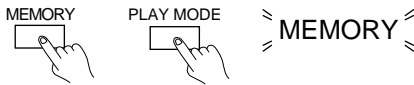

2 Using the AMCS knob, select the tracks in order you want to play.

Turn the AMCS knob until the track number you want to store is displayed (the playing time of the track is displayed). Then, press the AMCS knob to store the track.

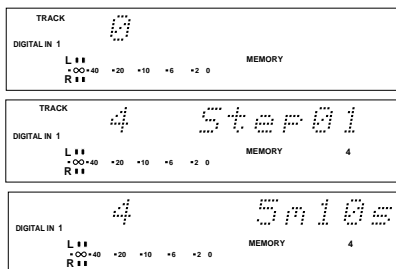
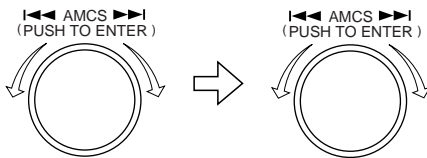

Note

If the total playing time of the programmed tracks exceeds 256 minutes, "---m--s" will be displayed.

3 Press the ►/II button (or the ► button on the remote controller) to start Memory play.

When the playing of all stored tracks is over, the MD recorder stops, retaining the stored tracks in memory.

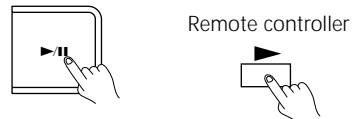

Playing track number



To exit the Memory play mode

When the MD recorder is stopped, press the CONTINUE button on the remote controller (RC-409MD).

With the RC-398S remote controller, press the PLAY MODE button until "MEMORY" disappears from the display.

Clearing the last track stored

Press the CLEAR or ■ button on the remote controller.

The last track in memory is cleared.

Checking the stored contents

To check the tracks stored in memory, press the ◀◀/▶▶ button when the MD recorder is stopped.

Memory play (continued)

Selecting a track using the remote controller

(RC-409MD)

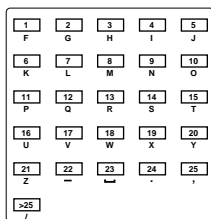

(RC-398S)

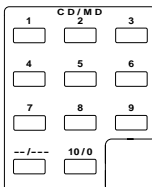

To select a track numbered 26 or above using RC-409MD

Press the [>25] button first. Set a value for the 10th place and then the 1st place using the number buttons in this order. ("0" can be entered by pressing the [10] button.)

Ex.

To select the 30th track

[>25] + [3] + [10]

To select the 100th track

[>25] + [>25] + [1] + [10] + [10]

To select a track numbered 11 or above using RC-398S

Press the [--/---] button first. Set a value for the 10th place and then the 1st place using the number buttons in this order. ("0" can be entered by pressing the [10/0] button.)

Ex.

To select the 30th track:

[--/---] + [3] + [10/0]

To select the 100th track:

[--/---] + [--/---] + [1] + [10/0] + [10/0]

Using the Auto Space function (RC-409MD only)

It is possible to play back the MD with a silent interval of approximately 3 seconds between tracks.

- Press the A.SPACE button on the remote controller.

The present setting will be displayed

("A.Space On" or "A.Space Off").

When "A.Space ON" is selected, the Auto Space function will operate.

Press A.Space button while the display is lit to switch between On and Off.

A.SPECE

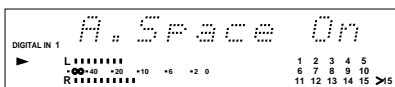
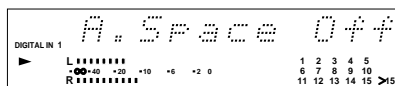

CD-dubbing (System operation)

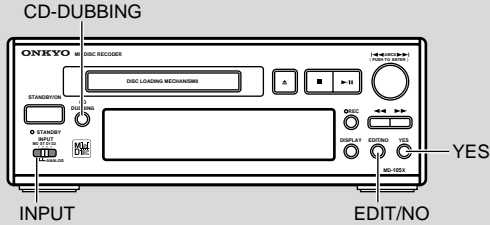

CD-dubbing (System operation)

Setting the CD dubbing mode

You can set either "Album" or "Fadeout" CD dubbing mode. In the Album CD dubbing mode, the track being recorded will be discarded if the end of MD is reached during recording. In the Fadeout CD dubbing mode, however, a fadeout effect will be applied to the last but incompletely recorded track of MDs.

The CD dubbing mode setting is possible only when the MD recorder is stopped.

- When your MD-105X is configured into a system with Onkyo Separate Collection series components (A-905X and C-705X), recording from the CD dubbing can be started simply pressing the CD DUBBING button on the MD-105X.
- To perform CD dubbing, your CD player must be connected through an optical cable to the DIGITAL INPUT 1 terminal located on the rear panel of the MD recorder. (for details, see the section "System connections" of the A-905X Instruction Manual.)
- For the normal recording procedure, see "Recording from an analog source" on page25 or "Recording from a digital source" on page28.

Note

CD-dubbing is not available with the A-905, C-705 and C-707CH.

1 Load the CD in the CD player.

See the C-705X CD player instruction manual for how to load CDs.

2 Load recordable MD in the MD105X.

To check the time remaining for recording...

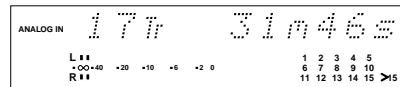
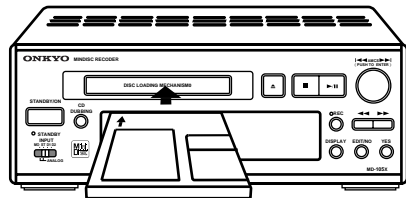

When the MD recorder is stopped, pressing the DISPLAY button changes the display as follows.

The number of tracks on MD and its total recorded time

↓
Remaining recording time on MD

↓
Disc name ("No Name" when not set)

3 Set the INPUT selector to "Digital In1" (D1) position.

The digital input source 1 is now selected.

Note

Cd-dubbing is not possible when "Analog In" or "Digital In 2" is shown on the display.

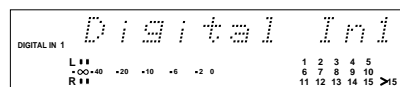

CD-dubbing (System operation)

4 Press the EDIT/NO button to display "CD Dub Mode".

4-1 Press the EDIT/NO button repeatedly until "CD DubMode?" appears.

EDIT/NO



CD DubMode?

4-2 Press the YES button.

The current CD dubbing mode is shown. ("Fade→Album?" indicates that you are switching from the Fadeout to Album CD dubbing mode.)

4-3 Press the YES button.

To stop halfway the CD dubbing mode setting, press the EDIT/NO button.

YES



Fade → Album?

5 Press the CD DUBBING button on the MD-105X

The CD player automatically searches for the disc's peak level, while the MD-105X sets the optimum peak level and then enters the recording standby mode. The MD-105X starts digital recording the whole disc as soon as the disc's first track starts playing. (DLA Link)

The recording stops automatically when the playback of all disc tracks is completed.

CD DUBBING



To stop the recording...

Press the ■ button.

DLA Link: Digital Rec Level Adjustment

CD-dubbing with track specified

When this MD recorder is configured into a system with A-905X and C-705X only one track with CD playing or pausing can be recorded by one-touch operation.

1 Play a CD

Play your desired track.

C-705X

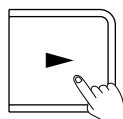

2 Press the CD DUBBING button.

Playing returns to the head of the track being played and only this track will be recorded (with DLA Link activated).

CD DUBBING



When the track reaches the end, next track will start and the MD recorder will stop.

Note

When the CD-dubbing mode is set to "Fadeout", the track will be faded out at the end of recording if the whole track cannot be recorded.

When the Album CD dubbing is selected and only one track will be recorded, recording will be continued until the end of MD is reached and the track being recorded will not be discarded if the end of MD is reached in the middle of recording.

Analog recording

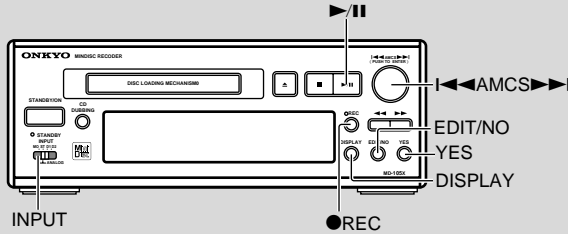

In analog recording, audio connection cables are used for inputting signals from the recording source.

1 Press the STANDBY/ON button.

The STANDBY indicator goes out.

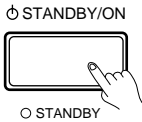

2 Load a recordable MD.

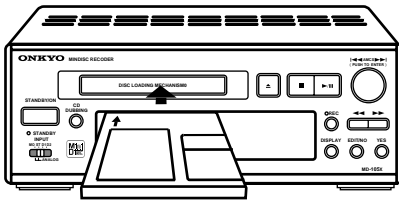

Number of recorded tracks Total recorded time
on MD

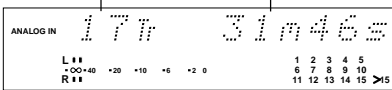

Note

When "Protected" is shown in the display, it indicates that the record-protect tab of the MD is open. Before starting the recording procedure, close the tab. (See page 36.)

To check the time remaining for recording

When the MD recorder is stopped, press the DISPLAY button. Each press of the DISPLAY button changes the display as follows:
The number of tracks on MD and the total recorded time → Remaining recording time on MD → Disc name ("No Name" when not set)

To record by erasing all of the existing tracks on a prerecorded MD

Erase all the tracks before you start recording (see page 37).

3 Set the INPUT selector to "ANALOG (MO or ST)" position.

The input source is now set to "Analog". Monaural recording enables you to record about twice the duration of stereo recording.

Note

- Make sure that the INPUT selector and the REC selector on the amplifier are set to an appropriate recording source.
- Do not change the INPUT selector setting during recording.

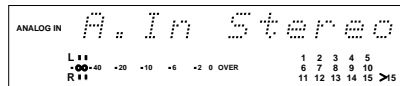
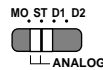

Analog recording (continued)

4 Press the ● REC button.

The MD recorder is now in the recording standby mode.

- When your MD-105X is configured with C-705X and K-505X, start playing the CD or tape before pressing the REC button in step 4.

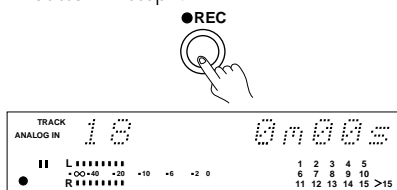

5 Using the AMCS knob, adjust the recording level.

Adjust the recording level.

5-1 Press the EDIT/NO button until "Rec Level?" appears.

Then, press the YES button.

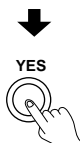
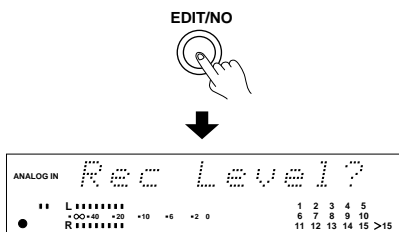

5-2 Turn the AMCS knob to adjust the recording level.

Adjust the recording level such that the -6 to -2 dB indicator lights when the input signal is largest. (Also refer to the current recording level readout displayed in dB.) Then, press the YES button.

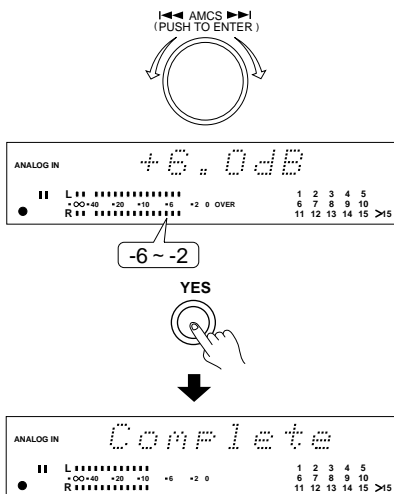

When the recording level adjustment is completed, stop playing the source.

6 Press the ►/|| button and then start playing the recording source immediately.

The TOC indicator appears as recording starts.

The MD recorder will automatically stop when recordable time on the disc expires.

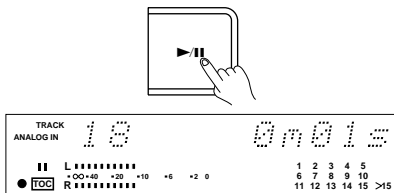

Analog recording (continued)

Since the interval between tracks is detected based on the sound level, some tracks may not be numbered correctly in the following cases:

- Recorded condition of the cassette tape is bad (noise between tracks).
- Low sound level in quiet music.
- Interval between tracks is extremely short.
- Tuner's reception is bad (noise).

To disable this function refer to the explanation below on this page.

To manually record a track number

While recording, press the ● REC button when you wish to mark a track number.

If you wish to mark two or more track numbers sequentially, provide a sufficient interval between each press of the ● REC button. Too short (about 4 seconds or less) an interval may lead to a failure in marking track numbers.

To stop recording temporarily...

Press the ►/|| button (or the || button on the remote controller). To resume recording, press the ►/|| button (or press the ► button on the remote controller).

To stop recording...

Press the ■ STOP button.

To eject the MD...

Press the ■ STOP button, then the ▲ EJECT button.

Note

If TOC is flashing when you press the ▲ EJECT button or the STANDBY/ON button, it means the MD recorder is writing the recorded contents onto the MD. During this period, do not disconnect the power cord or apply strong vibrations to the MD recorder. Doing so may prevent normal recording onto the MD.

If the MD recorder's power cord is connected to the

SWITCHED service power outlet on the rear panel of your amplifier, etc., do not turn off the amplifier.

To disable the automatic track numbering function...

Perform the following steps while you are recording or waiting for the recording to start:

EDIT/NO

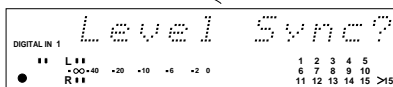

1. Press the EDIT/NO button.
"LevelSync?" appears on the display.
2. Press the YES button.

YES

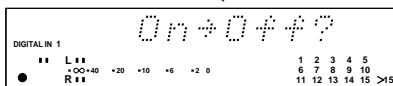

- If the function is currently turned on.
"On → Off?" appears on the display.
3. Press the YES button.
"Lv1SyncOff" appears on the display.

YES

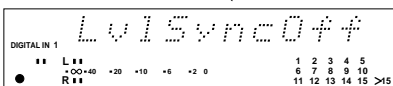

Now the tracks will not be numbered during recording.

- Press the EDIT/NO button any time if you wish to cancel the setting.

To enable the automatic track numbering function...

Perform the following steps while you are recording or waiting for the recording to start:

- Press the EDIT/no button.
"Level Sync?" appears on the display.
- Press the YES button.
If the function is currently turned off,
"Off → On?" appears on the display.
- Press the YES button.

Digital recording

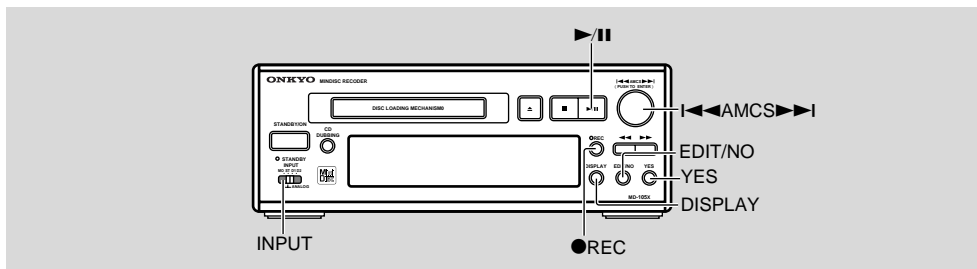

Digital recording refers to recording where an optical digital cable is used for inputting signals from the recording source.

This MD recorder contains a digital input signal sampling frequency rate converter which converts the sampling frequency of digital input signals to 44.1 kHz before recording.

This converter can handle the following sampling frequencies:

- 44.1 kHz (CD player, etc.)
- 32 kHz (DAT, satellite broadcasting, etc.)
- 48 kHz (DAT, satellite broadcasting, etc.)

1 Press the **STAND-BY/ON** button.

The STANDBY indicator goes out.

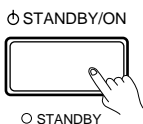

The number of tracks on MD and the total recorded time → Remaining recording time on MD → Disc name ("No Name" when not set)

To record by erasing all of the existing tracks on a prerecorded MD

Erase all the tracks before you start recording (see page 37).

2 Load a recordable MD.

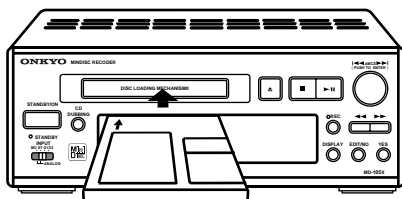

Number of recorded tracks Total recorded time on MD

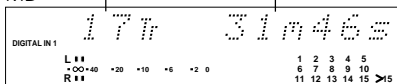

To check the time remaining for recording

When the MD recorder is stopped, press the DISPLAY button. Each press of the DISPLAY button changes the display as follows:

3 Set the **INPUT** selector to "Digital In1" (D1) or "Digital In2" (D2) position.

The digital input source 1 or 2 is now selected.

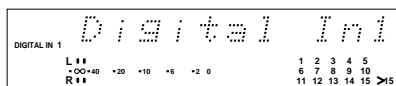
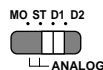

Note

Make sure which of the digital input terminals the supplied optical cable is connected to. If you attempt to perform digital recording using a digital input terminal which is not connected, "D.In Unlock" will appear. Use the DIGITAL INPUT 1 digital input terminal if you connect the C-705X CD player to this MD recorder.

4 Press the ● REC button.

The MD recorder is now in the recording standby mode.

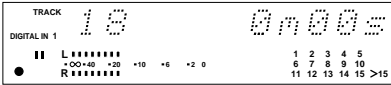

If "D. In Unlock" appears

The digital input source is not connected properly. Check the connection for the digital input source.

5 Using the AMCS knob, adjust the recording level.

Adjust the recording level.

5-1 Press the EDIT/NO button until

"Rec Level?" appears.

Then, press the YES button.

EDIT/NO



YES



5-2 Turn the AMCS knob to adjust the recording level.

Adjust the recording level such that the -6 to 0 dB indicator lights when the input signal is largest. (Also refer to the current recording level readout displayed in dB.) Then, press the YES button.

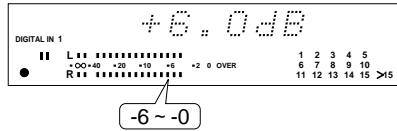
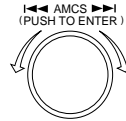

YES



When the recording level adjustment is completed, stop playing the source.

6 Press the ►/|| button and then start playing the recording source immediately.

The MD recorder stops recording automatically when the remaining space on the MD is not enough to record the next track.

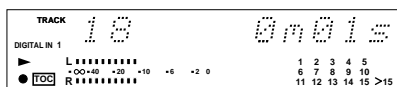
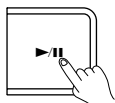

To stop recording temporarily

Press the ►/|| button (or the || button on the remote control). To resume recording, press the ►/|| button again (or press the ► button on the remote control).

To stop recording

Press the ■ button.

To eject the MD

Press the ■ button and then the ▲ EJECT button.

Note

If TOC is flashing when you press the ▲ EJECT button or the STANDBY/ON button, it means the MD recorder is writing the recorded contents onto the MD. During this period, do not disconnect the power cord or apply strong vibrations to the MD recorder. Doing so may prevent normal recording onto the MD.

- For track numbers to be marked automatically, the signature code included in the digital signal at the beginning and ending of each track is necessary. Some equipment and broadcasts do not include this signal, and in such a case track numbers will not be marked automatically.

Signal Wait function

When "LvlSyncOn" is active and the unit receives no audio signal from the recording source for 10 seconds, the unit enters the "Signal Wait" status in which the unit waits for the audio signals from the source for approx. 20 seconds. The unit resumes recording if it receives the signals from the source within the specified period of time. Otherwise, press the ►/|| button in order to resume recording. (Not applicable while in CD-dubbing mode.)

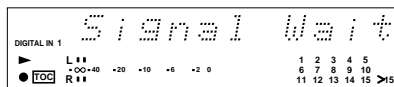

Signal Synchro recording

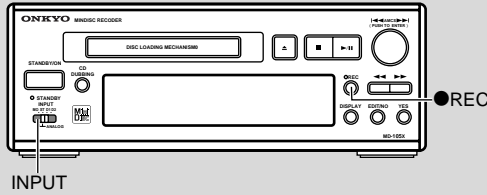

Even if your recording source is not Onkyo **RI**-compatible, you can perform synchronized recording.

1 Use the INPUT selector to select MO, ST, D1, or D2, according to the connected device.

- You can perform signal synchro recording with both digital and analog recording sources.

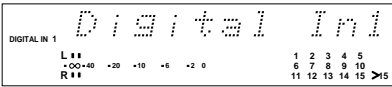
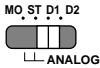

3 Recording starts.

Recording starts as soon as the unit receives signals from the recording source while "Signal Wait" is displayed.

(Recording source)

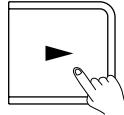

Note

Signal synchro recording is performed with Level Sync automatically set to On.

2 Press the REC button twice to display "Signal Rec."

"Signal Rec" appears, then the unit enters the Signal Wait mode.



Signal Rec



Signal Wait ↔ 0000s

Note

If no signal is input for approx .30 seconds, the MD recorder will enter recording standby mode.

System operation

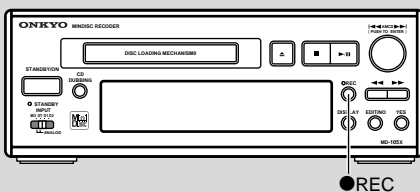

CD-synchro recording

When your MD recorder is configured into a system with Onkyo Separate Collection series components (A-905X and C-705X), the operation of the MD recorder can be synchronized with that of the CD player.

1 Set the MD recorder to the recording standby mode.



- For how to set the MD recorder to the recording standby mode and the necessary preparatory steps, see "Analog recording" or "Digital recording".

For digital CD-synchro recording

Connect the CD player's (optical) digital output terminal to the MD-105X's DIGITAL INPUT 1 terminal.

2 Start playing the CD.

The MD recorder starts recording as soon as the CD starts playing.

If your cassette deck is also in the recording standby mode, it starts recording simultaneously.

When playing of the CD completes, the MD recorder stops recording and enters the recording standby mode.

(C-705X)

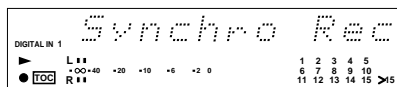
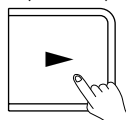

To stop CD-synchro recording

Press the ■ button on the CD player. The MD recorder then enters the recording standby mode.

Note

For analog recording, set the input selector of the A-905X to the CD position and keep it placed in that position during recording. Changing the input selector setting causes the MD recorder to stop and then enter the recording standby mode.

System operation (continued)

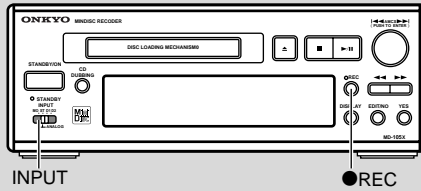

Synchro-recording from cassette deck to MD (Cassette Synchro recording)

When your MD-105X is configured into a system with Onkyo Separate Collection series components (A-905X and K-505X), synchronized recording from the cassette deck to the MD recorder is possible.

1 Set the input selector to the ST (stereo) or MO (monoral) Position

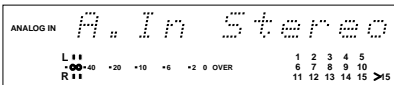

- You cannot perform this synchro recording with the "Digital In1" or "Digital In2" input sources.

2 Set the MD recorder to the recording standby mode.

- For how to set the MD recorder to the recording standby mode and the necessary preparatory steps, see "Analog recording" on page 25.



3 Start playing the cassette deck.

The MD recorder starts recording as soon as the cassette deck starts playing. When playing of the cassette deck completes, the MD recorder stops recording and enters the recording standby mode.

(K-505X)

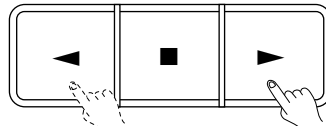

To stop synchro recording

Press the  button on the cassette deck. The MD recorder then enters the recording standby mode.

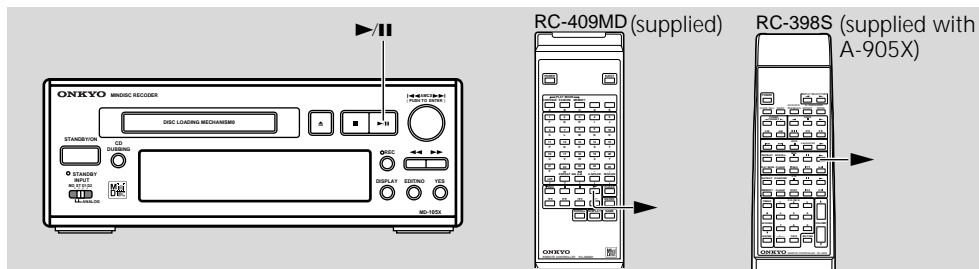

System operation (continued)



Synchro-recording from MD to cassette deck

When the MD-105X is configured into a system with Onkyo Separate Collection series components (A-905X and K-505X), synchronized recording from the MD recorder to the cassette tape deck is possible.

To stop synchro recording

Press the  button on the MD recorder. The cassette deck enters the recording standby mode while showing a blinking  indication (Auto Space).

1 Insert a cassette tape in the cassette tape deck and set the cassette tape deck in the recording standby mode.

- See the cassette tape deck instruction manual for how to set the deck in the recording standby mode.

(K-505X)



2 Press the ▶|| button on the MD recorder (or the ▶ button on the remote controller).

The cassette tape deck starts recording as soon as the MD starts playing.

When the MD program is completed, the cassette tape deck stops recording and enters the recording standby mode again.

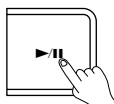

System operation (continued)

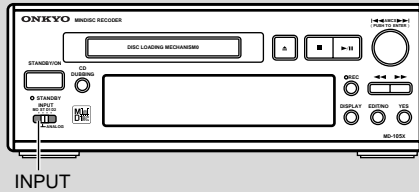

Timer operation

When your MD recorder is configured into a system with Onkyo Separate Collection series components (A-905X and T-405X), you can record the desired broadcasting programs or play your favorite MD at a specified time using the tuner's timer. See the T-405X instruction manual for how to use the Timer function.

1 Insert an MD.

You can perform both playing and recording.

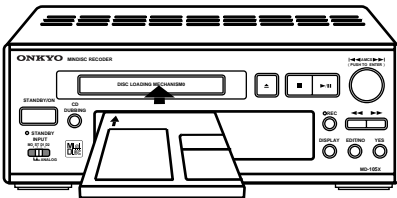

2 Set the INPUT selector to ST (stereo) position.

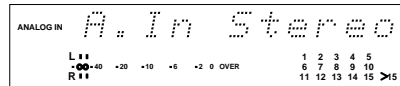
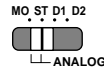

3 Set the timer on your T-405X.

Note

Connect the AC power cord of your MD-105X to a normally live outlet. If you connect the power cord to the outlet on the rear of the A-905X, do not turn off the main power (POWER switch) of the A-905X.

Other information for recording

Checking the contents of recording

- If you have not operated the unit since stopping a recording, the track to be played will flash in the music calendar. Press the ►/|| button to start playing the flashing track.
- To playback from the beginning of the MD, immediately after recording is stopped, press the ■ button again. Then, press the ►/|| button (or the ► button on the remote controller) to start playback.

Storage period of backup data

The recorded contents will be backed up in the MD-105X even if the MD recorder's power cord is accidentally unplugged or if a power failure occurs before they are stored to the disc (when TOC is lit) or when they are being stored to the disc (when TOC is flashing). You can restore the data which was backed up during such an accident or power failure by pressing the STAND BY/ON button after plugging in the power cord or immediately after the power failure is solved. Note, however, that the period in which the backup data is stored is approx. only 2 weeks. So, especially after a power failure, perform the above procedures as soon as possible after power is restored.

Protecting recordings from accidental erasure

You can make your MDs impossible to be recorded on by sliding the record-protect tab on the MDs to open the record-protect hole. To make the MDs recordable again, return the record-protect tab.

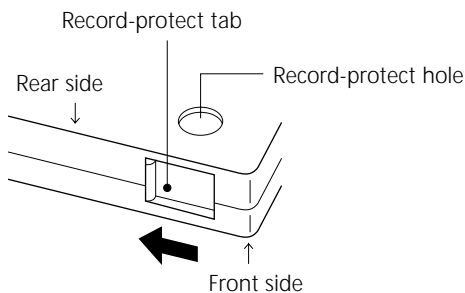

Editing the contents of an MD

Erasing a track

The following operation is possible when the unit is stopped or paused.

- 1 Turn the AMCS knob until the track number you want to erase is displayed.

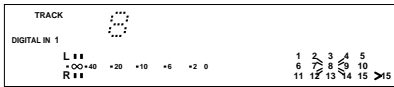
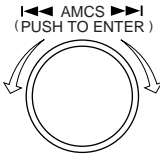

- 2 Press the EDIT/NO button several times until "Erase?" appears in the display.

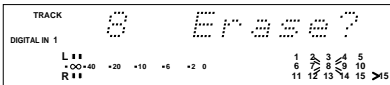

To stop erasing a track

Press the EDIT/NO button until "Erase?" disappears, or press the **■** button.

- 3 Press the YES button.

The selected track is erased. When the erasing of the track is completed, "Complete" appears in the display.

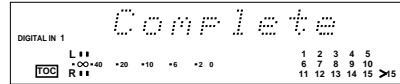

- When a track is erased, the tracks following that track are advanced, each given a new number which is smaller by one track than the previous track number. For example, if you erase track 2, track 3 will now be renumbered as track 2; track 4 will now be renumbered as track 3, and so on.

Note

While the TOC indicator is lit or flashing, do not move or unplug the MD recorder.

To erase all tracks of an MD

- 1 Press the **■** button.
- 2 Press the EDIT/NO button several times until "All Erase?" appears in the display.
To cancel, press the EDIT/NO button or press the STOP button.
- 3 Press the YES button. "All Erase??" is displayed for confirmation.
On the display, the music calendar flashes.
- 4 Press the YES button again.
When the erasing of all tracks of the MD is completed, "Complete" appears in the display.

Note

While the TOC indicator is lit or flashing, do not move or unplug the MD recorder.

Editing the contents of an MD (continued)

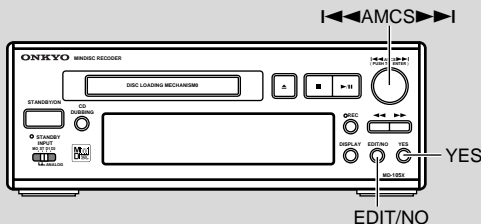

Dividing a track

The following operation is possible during the playback is ongoing or paused.

- 1 Press the **EDIT/NO** button several times until "Divide?" appears in the display.

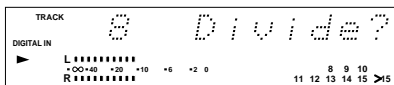

To stop dividing a track

Press the **EDIT/NO** button until "Divide?" disappears, or press the **■** button.

- 2 Press the **YES** button.

The part at which the track is to be divided plays repeatedly, with "Rehearsal" and "Position OK?" alternately shown on the display.



- 3 Turn the **AMCS** knob while listening to the part being played.

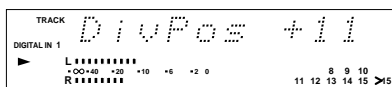
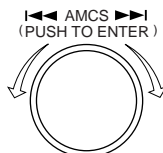

Fine adjust the point where you wish to divide the track.

Within the playing part, you can move the dividing point in the range of -128 to +127. (Increasing or decreasing the dividing point by 1 corresponds with approximately 0.05second.)

Dividing point
(0.5-sec silence)

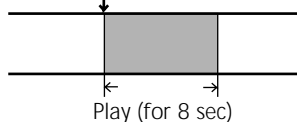

- 4 Press the **YES** button to divide the track.

When the dividing of the track is completed, "Complete" appears in the display.

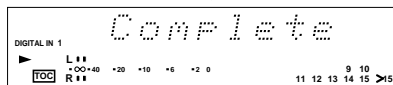

Editing the contents of an MD (continued)

- When a track with a name is divided into two parts, the former part takes over the name and the latter part is left without a name.
- When a track is divided, the tracks following that divided track are moved backward, each given a new number which is larger by one track than the previous track number. For example, if you divide track 2 into two parts, the latter part will now be renumbered as track 3; the track 3 will now be renumbered as track 4; the track 4 will now be renumbered as track 5, and so on.

To erase parts of a track, first divide the track in parts and then erase the parts you wish to erase. (See page 37 for how to erase tracks.)

Note

While the TOC indicator is lit or flashing, do not move or unplug the MD recorder.

Combining tracks

You can combine two adjacent tracks into one. You cannot, however, combine the two tracks if the one of which is recorded in the MO (monaural) mode and the other in the ST (stereo), Digital In1, or Digital In2 mode.

The following operation is possible when the unit is stopped, paused or playing.

1 Turn the AMCS knob until the latter of the new track numbers is displayed.

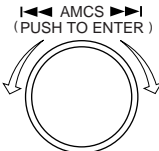

- The selected track will be combined with the previous track.
- If each of the combined tracks has a title, the previous track's title will remain and the latter track's title will be erased.
- If the previous track only has a title, that title will remain.

- If the latter track only has a title, that title will be lost.

2 Press the EDIT/NO button several

EDIT/NO

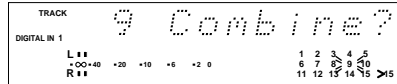

times until "Combine ?" appears in the display.

To stop combining tracks

Press the EDIT/NO button until "Combine?" disappears, or press the button.

3 Press the YES button.

YES

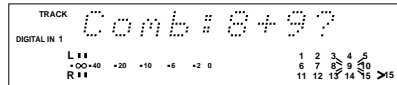

The two tracks to be combined are indicated on the display.

4 Press the YES button again.

Check the part of the two tracks to be combined.

The part at which the two tracks are to be combined plays (for 8 seconds) repeatedly, with "Rehearsal" and "Position Ok?" alternately shown on the display.

YES



Combining point

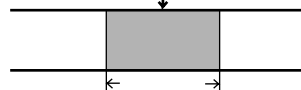

Play (for 8 sec)

(Continued to the next page) 39

5 Press the YES button to combine the tracks you have selected.

When the combining is completed, "Complete" appears in the display.

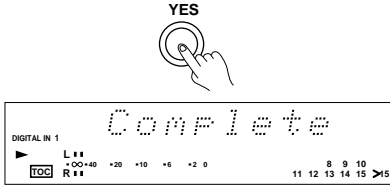

- When tracks are combined, the tracks following those tracks are advanced, each given a new number which is smaller by one track than the previous track number. For example, if you combine track 3 with track 2, track 4 will now be renumbered as track 3; track 5 will now be renumbered as track 4, and so on.

Note

While the TOC indicator is lit or flashing, do not move or unplug the MD recorder.

Editing the contents of an MD (continued)

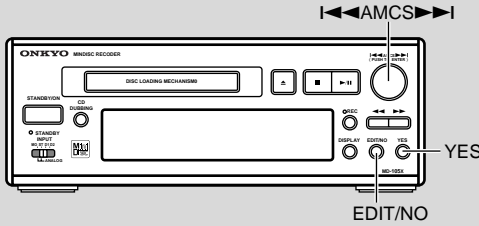

Moving a track

The following operation is possible when the unit is stopped or paused.

- 1 Turn the AMCS knob until the track number you want to move is displayed.

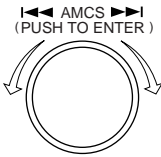

- 2 Press the EDIT/NO button several times until "Move?" appears in the display.



To stop moving a track

Press the EDIT/NO button until "Move?" disappears, or press the  button.

- 3 Press the YES button.

The selected track number and a destination track number appear in the display.

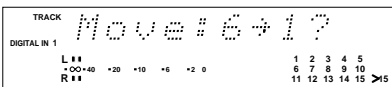

- 4 Turn the AMCS knob until the desired destination track number is displayed.

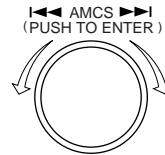

- 5 Press the YES button to move the selected track.

When the moving of the track is completed, "Complete" appears in the display.

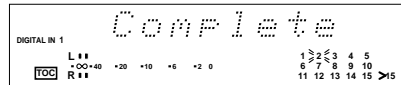

- When a track is moved, the track numbers are renumbered, based on the track number of the moved track, so that they are consecutive. For example, if you move track 3 to track 1, track 1 will now be renumbered as track 2; track 2 will now be renumbered as track 3, and so on.

Note

While the TOC indicator is lit or flashing, do not move or unplug the MD recorder.

Naming a track or disc

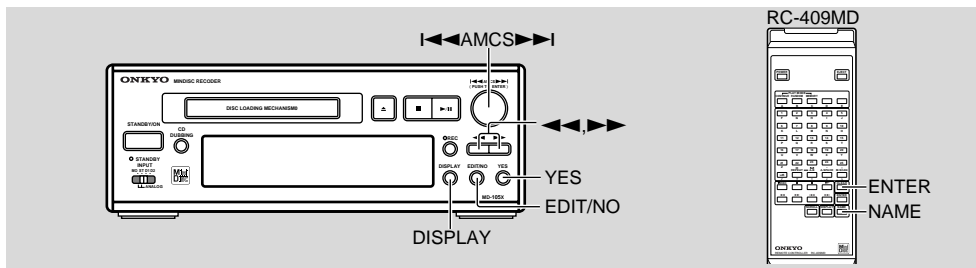

To name a disc

The MD recorder must be stopped.

To name a track

The MD recorder may be stopped, paused, playing, or recording.

(The characters being entered are canceled if the track which is playing or being recorded changes.)

1 Turn the AMCS knob until the track number which you want to enter a name is displayed.

- To name a disc, start from step 2, skipping step 1.

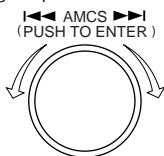

Note

When the MD recorder is paused, playing, or recording, the track number which is displayed is selected, and therefore, this step is unnecessary.

2 Press the EDIT/NO button several times until "Name In?" appears in the display.

Or, with the supplied remote controller, press the NAME button.

When you name a track, the TRACK indicator will turn on.

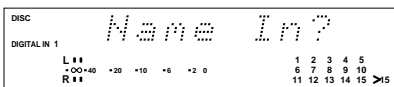
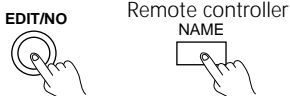

To stop naming a disc or track

Press the STOP or YES button while pressing the EDIT/NO button.

3 Press the YES button.

The blinking cursor appears.



4 Select the character input mode using the DISPLAY button.

DISPLAY

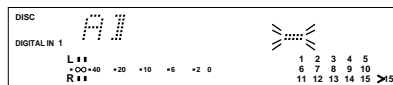

- You can enter upper case letters, lower case letters, numbers and symbols. Each press of the DISPLAY button changes the type of characters you can enter as follows:

Naming a track or disc (Continued)

Upper case letter (A, B, C...)



Lower case letters (a, b, c...)



Numbers and symbols (1, 2, 3...)



Easy title (♪)

- With the supplied remote controller (RC-409MD), press the DISPLAY button to change the character input mode.

5 Enter a track name or disc name using the AMCS knob.

Turn the AMCS knob to display the character you want to enter, and then press the AMCS knob to enter it.

Following the same procedure, enter the remaining characters.

You can enter up to 100 characters, depending on the type of characters you enter.

(RC-409MD)

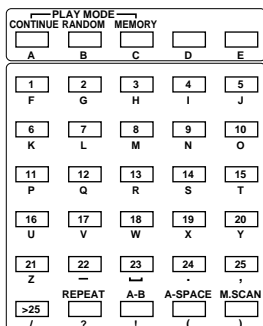
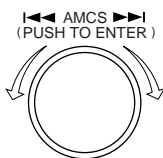

To enter a name with the supplied remote controller (RC-409MD)

You can enter numbers (1 to 9, 0 by the 10 button), uppercase and lowercase letters, and symbols (only those indicated below the buttons) by directly operating the buttons.

The ◀◀ and ▶▶ buttons on the remote control can be used to select

characters. If this is the case, press the ENTER button or the ▶▶ button to enter them.

To change the type of characters entered

Go back to step 4 and change the character input mode. Then, select and enter characters using the AMCS knob.

To correct the character entered

Move to the character you want to correct using the ◀◀ and ▶▶ buttons (the character blinks), and then reenter the character you want.

To insert a character

Move to the point at which you want to insert a character using the ◀◀ and ▶▶ buttons (the insertion point blinks). Then turn the AMCS knob counterclockwise (◀◀ blinks) and press the AMCS knob (the cursor blinks). Finally, enter the character you want.

To erase a character

Move to the character which you want to erase using the ◀◀ and ▶▶ buttons (the character blinks) and then press the EDIT/NO button or CLEAR button on the remote controller (RC-409MD).

6 Press the YES button.

With the supplied remote controller (RC-409MD), press the NAME button.

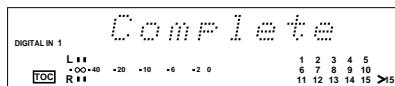
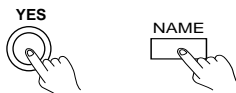

Note

If, after pressing the EJECT or STANDBY/ON button, the TOC indicator is flashing, it indicates that MD recorder is writing the recorded contents onto the MD. To ensure correct writing to the MD, do not disconnect the power cord (mains lead) or move the unit during this period.

(Continued to the next page)

Naming a track or disc (Continued)

Preset titles for easy titling

In the Easy Titling mode, you can enter the following titles by simply choosing one.

BALLAD	Anthology
BLUES	Best of
CLASSIC	(One space will be
DANCE	added following " of".)
FUSION	Collection
JAZZ	Favorite
LIVE	Happy
POPS	Heavy
REGGAE	Hit Song
ROCK	Omnibus
SOUL	Selection
TECHNO	Special
VOCAL	Super
African	Space ()
American	(To enter a space,
Asian	choose the symbol
British) .)
Euro	
German	
Japanese	

Erasing the disc name and all track names at one time

1 Press the STOP button.

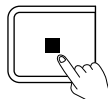

2 Press the EDIT/NO button to display "Name Erase?".

Press the EDIT/NO button several times until "Name Erase?" appears.

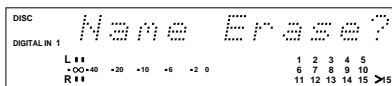

3 Press the YES button.

All track names and the disc name are erased.

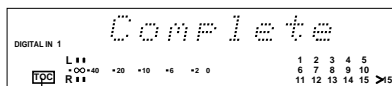

Lights when completed

Canceling the last editing

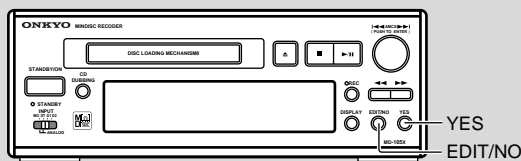

The UNDO function

The UNDO function cancels the last editing you performed with the ALL ERASE, ERASE, DIVIDE, COMBINE, MOVE, or NAME ERASE function. To undo the last editing, press the STOP button and perform the following steps:

1 Select "Undo?".

Press the EDIT/NO button several times until "Undo?" appears on the display.

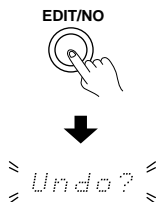

To deselect "Undo?"

Press the EDIT/NO button repeatedly or press the STOP button.

2 Undo the last editing.

Press the YES button.
Once the previous editing has been successfully canceled, "Complete" message will appear on the display.



Note

The UNDO function will not be available for:

- Redoing the undone editing
- Undoing the editing when no editing has been performed yet.
- Undoing the editing once the recording has been finished.
- Undoing the editing once you removed the disc and loaded it again.
- Undoing the editing once you pressed the STANDBY/ON button, and then pressed it again.

Message list

The following table explains the various messages that appear in the display.

Message	Meaning
Blank Disc	A new recordable MD or a recordable MD without disc or track names is inserted.
Cannot Copy	An attempt was made to make a second copy from a digitally dubbed MD (see "Rules for Digital Recording" on page 48).
Cannot Edit	An attempt was made to edit the disc during MEMORY or RANDOM play or in recording standby mode, or an attempt to edit a premastered disc was made.
Cannot Rec	An attempt was made to record onto a premastered (read-only) disc.
D. In Unlock	The digital equipment (CD player, DAT, etc.) has not been connected properly. Otherwise, the connected digital equipment is not operating properly.
Disc Error	The disc is abnormal (scratched or missing a TOC).
Disc Full	The disc is full (see "System Limitations" on the next page).
Impossible	The disc could not be edited.
Mecha Error	An error occurred in the unit's internal mechanism.
Memory Full	An attempt was made to record a 26th track.
Name Full	Number of characters has reached the limit for input to one MD.
No Change	The naming attempt failed.
No Disc	There is no disc in the unit.
No Track	The inserted disc has a disc title but no tracks.
Not Audio	An attempt was made to play a non-audio disc.
Over	In pause mode (when playing is paused), the ►► (Fast Forward) button was pressed to the end of the disc.
Protected	The inserted disc is record-protected.
Retry Error	The recording attempt failed due to a consecutive disturbance or scratches on the MD.
Temp Over	An abnormally high temperature is detected in the unit's internal mechanism.
U-TOC Error	The writing of the recorded or edited contents Failed.
TOC Writing	The unit is writing the recorded or edited contents to the MD.
Full	An attempt was made to enter a character over the maximum character capacity while naming.

System limitations

The recording system in your MiniDisc recorder is radically different from those used in cassette and DAT decks and is characterized by the limitations described below. Note, however, that these limitations are due to the inherent nature of the MD recording system itself and not to mechanical causes.

- **"Disc Full" lights up even before the disc has reached the maximum recording time (60, 74 or 80 minutes)**

When 255 tracks have been recorded on the disc, "Disc Full" lights up regardless of the total recorded time. More than 255 tracks cannot be recorded on the disc. To record new tracks, erase unnecessary tracks or use another MD.

- **"Disc Full" lights up before the maximum number of tracks is reached**

Fluctuations in emphasis within tracks are sometimes interpreted as track intervals, incrementing the track count and causing the "Disc Full" indication to light up.

- **The remaining recording time does not increase even after erasing numerous short tracks**

Tracks of under 12 seconds in length are not counted and so erasing them may not lead to an increase in the recording time.

- **Some tracks cannot be combined with others**

Track combination may become impossible when tracks are edited.

- **The total recorded time and the remaining time on the disc may not total the maximum recording time (60, 74 or 80 minutes)**

Recording is done in minimum units of 2 seconds each, no matter how short the material. The contents recorded may thus be shorter than the maximum recording capacity. Disc space may also be further reduced by scratches.

- **Track created through editing may exhibit sound dropout during searching operations.**

- **Track numbers are not recorded correctly**
Incorrect assignment or recording of track numbers may result (1) when CD tracks are divided into several smaller tracks during digital recording, or (2) when certain CDs are recorded with the Level Sync On for automatic track marking.

- **TOC indicator appears for a long time**

If the inserted recordable disc is brand new, the TOC indicator appears on the display longer than those that have been used.

Rules for digital recording

Guide to the serial copy management system

Since your MD unit uses the Serial Copy Management System (SCMS), MDs recorded through the digital input terminal cannot be used to make subsequent copies to other MDs through the digital output terminal. The following diagram shows a system for making copies through the digital or analog terminals.

Rule 1

You can record digital source (CD, premastered MD, and DAT equipment with a sampling frequency of 44.1 kHz) to a recordable MD through the digital input terminal.

However, you cannot make subsequent copies from the recordable MD to other recordable MDs through the digital output terminal. Subsequent copies can only be made through analog output terminal.

Rule 2

You can record the digital input signal of a digital satellite broadcast onto a recordable MD via the digital input terminals on MD recorder which is capable of handling a sampling frequency of 32 kHz or 48 kHz. You can then record the contents of this recorded MD (first-generation) onto another recordable MD via digital input terminals on the MD recorder to create a second-generation digital copy.

Note, however, that with some BS tuners, second-generation digital copying may not be possible.

Rule 3

A recordable MD with material recorded from analog sources (analog records or FM programs, etc.) through the line input terminal can be copied to another recordable MD through the digital output terminal.

However, you cannot make subsequent copies from the recordable MD to other recordable MDs through the digital output terminal.

Subsequent copies can only be made through analog output terminal.

* When MD recorders are connected using analog terminals, the number of dubbings is not limited.

Troubleshooting

If you encounter a difficulty while using your unit, use this troubleshooting guide as an aid to remedy the problem. Because the unit contains a microcomputer to provide advanced functions, it may malfunction due to external noise or static electricity. If this happens, disconnect the power cord and then plug it in again after about 5 seconds. You must also be sure that the system components are properly connected.

If the MD recorder still does not operate correctly, disconnect the power plug, then plug it in again while pressing EDIT/NO button and YES button simultaneously. Note that any **TOC** information held in this MD recorder will be erased by this operation. If the problem persists even after you try this remedy, or it is not listed in the table, disconnect the power cord and then consult the shop from which you purchased the unit or your nearest ONKYO service station, informing them of your name, address, phone number, type of unit, and the details of the problem.

Symptom	Cause	Remedy
The unit does not operate or operates poorly.	<ul style="list-style-type: none"> The disc may be damaged ("Disc Error" appears). 	<ul style="list-style-type: none"> Take the disc out and insert it again. If "Disk Error" remains, replace the disc. (See "Precautions for handling the MiniDisc (MD)" on page 51)
The unit does not play.	<ul style="list-style-type: none"> Moisture has formed inside the unit. The unit is not on. The disc is inserted in the wrong direction. The disc may not be recorded (the track numbers do not appear). 	<ul style="list-style-type: none"> Take the MD out and leave the unit in a warm place for several hours until the moisture evaporates (See page 50). Press the STANDBY/ON button to turn the unit on. Slide the MD into the disc compartment with the label side up and the arrow pointing toward the opening until the unit grips it (See page 14). Replace the disc with one that has been recorded.
The sound has a lot of static.	<ul style="list-style-type: none"> Strong magnetism from a television or a similar device is interfering with operations. 	<ul style="list-style-type: none"> Move the unit away from the source of strong magnetism.
The unit does not record.	<ul style="list-style-type: none"> The disc is record-protected ("Protected" appears). The unit is not connected properly to the sound source. The recording level is too low. A premastered disc is inserted. There is not enough time left on the disc. The optical digital cable for audio use is not connected properly. ("D. In Unlock" appears.) There has been a power failure or the power cord has been disconnected. 	<ul style="list-style-type: none"> Close the record-protect hole (See page 36). Make connections properly to the sound source. Adjust the recording level properly. Replace it with a recordable disc. Replace it with another recordable disc with fewer recorded tracks. Connect the optical digital cable properly or use analog input. The contents of the recording may be lost permanently. After connecting the power cord or immediately after power has been restored, press the STANDBY/ON button. (See page "Storage Period of Backup Data".)

Troubleshooting (Continued)

Symptom	Cause	Remedy
The disc name or track name cannot be entered.	<ul style="list-style-type: none">• The disc is record-protected ("Protected" appears).• A premastered (read-only) disc is inserted ("Cannot Rec" appears).	<ul style="list-style-type: none">• Close the record-protect hole (See page 36).• Replace it with a recordable disc.
System function cannot be used.	<ul style="list-style-type: none">• The system functions cannot be used.	<ul style="list-style-type: none">• Check all cable connections. The system functions cannot be used even if remote control (RI) cables are connected. Also connect the components using audio cables.

If the unit does not operate properly even after attempting the prescribed remedies, unplug and then plug in the power cord again.

Condensation

This is the same phenomena that causes windows to become misted up with water drops in a heated room during the winter.

The MD recorder also sometimes gets dew (water drops) on the optical lens inside the player under the following conditions.

- Immediately after you turn a heater on.
- If the MD recorder is placed in a room with full of steam or dampness.
- If you suddenly bring the MD recorder in from the cold outside into a warm room.

If the MD recorder is exposed to dew condensation

You can leave it as it is. Sometimes the recorder cannot read the signal sent from the disc by laser and the recorder doesn't work.

Depending on the surrounding conditions you can remove the disc and leave the power on for at the longest one hour. The dew will evaporate and the recorder will work properly. If it doesn't work after several hours, please consult the nearest Onkyo authorized service center.

Precautions for handling the MiniDisc (MD)

The MD is housed in a cartridge, so you can handle it without worrying about dust and fingerprints. Even so, a dirty or warped cartridge may cause malfunction. Always remember the following precautions so you can enjoy high-quality sound for a long time.

Do not touch the disc in the cartridge directly with your fingers.

Do not open the shutter by hand. Doing so may damage the disc.

Storage location

Avoid storing MDs in a place subject to direct sunlight, high temperature, or high humidity.

Regular care

Wipe off dust and dirt accumulated on the cartridge surface with a dry cloth.

Removing the halfway inserted MD

If the "self-rock function" is activated and the MD cannot be removed, push the MD further into the MD recorder and then press the ▲ EJECT button to remove the MD.

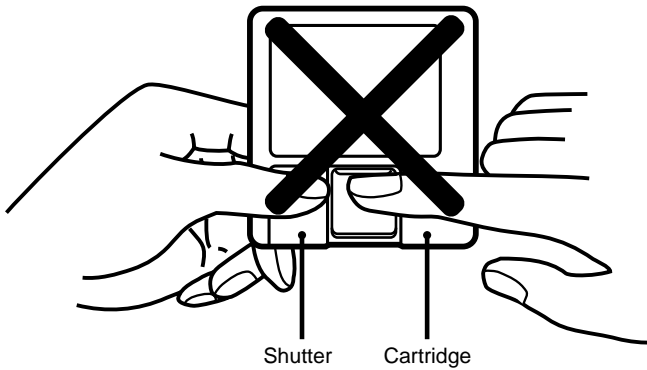

Indexed to parts and controls

Front panel

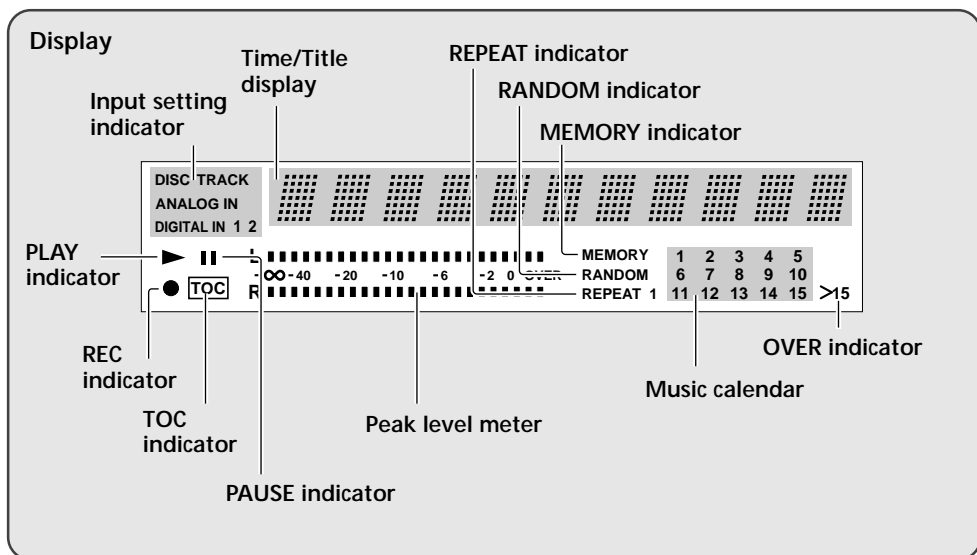
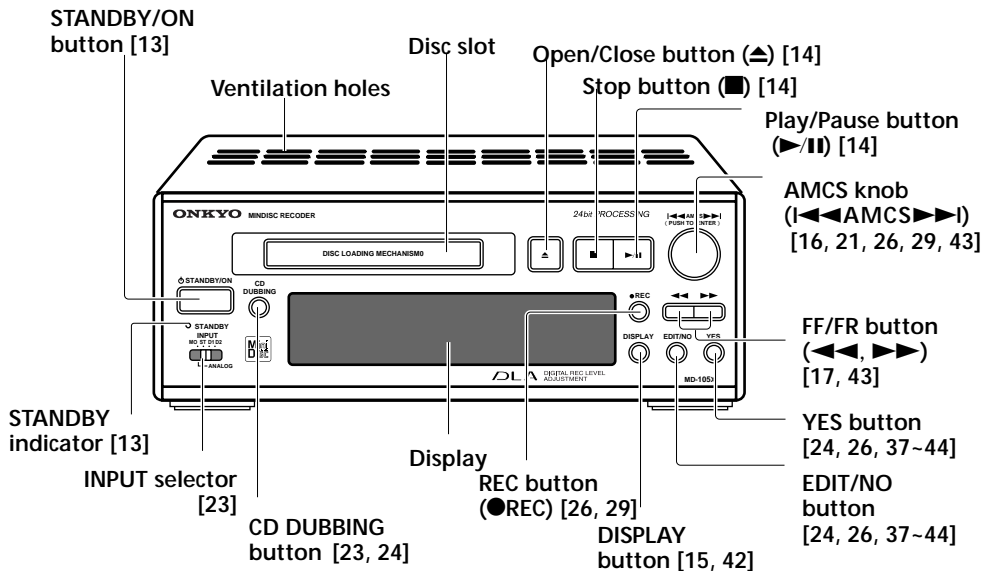

Remote controller

RC-409MD (supplied)

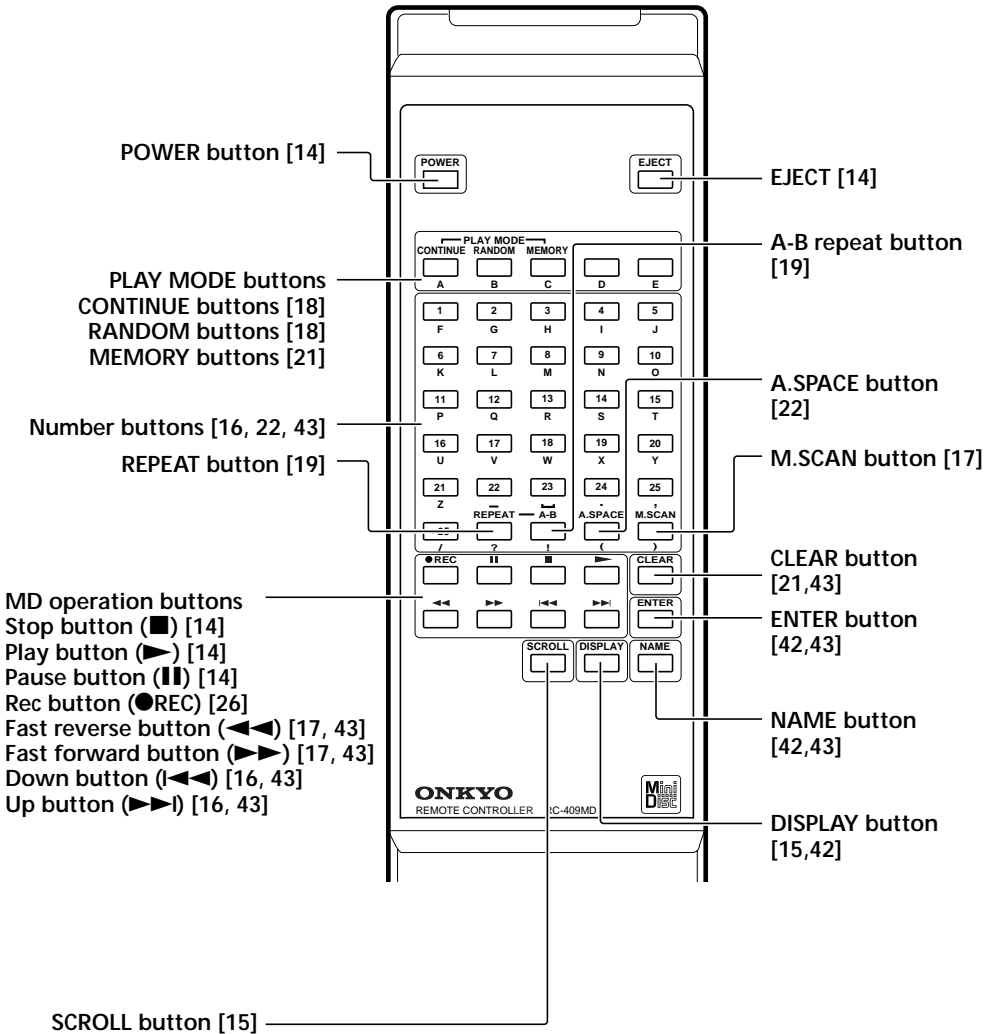

RC-398S
(supplied with the A-905X amplifier)

- MD operation buttons
 Stop button (■) [14]
 Play button (▶) [14]
 Pause button (||) [14]
 Rec button (●REC) [26]
 Down button (|◀◀) [16,43]
 Up button (▶▶|) [16,43]
 Repeat button (REPEAT) [19]
 Clear button (CLEAR) [21,43]
 Scroll button (SCROLL) [15]
 Play Mode button (PLAY MODE)
 [18,21]

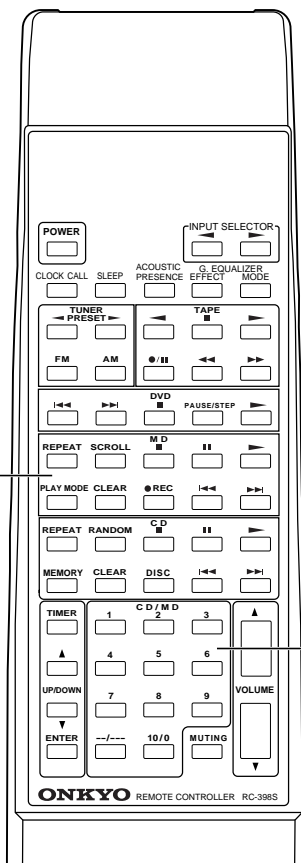

Number buttons
[16,22,43]

MEMO

Specifications

System

MiniDisc digital audio system

Recording system

Magnetic field modulation overwrite system

Signal read out system

Optical non-contact

Recording time

Stereo : Max. 80 min.
(when using MDW-80)

Mono : Max. 160 min.
(when using MDW-80)

Number of revolutions

About 400 - 900 rpm (constant linear velocity)

Error correction system

Advanced Cross Interleave Reed-solomon code

Sampling frequency

44.1 kHz

Number of channels

2 (stereo)

Frequency response

10 Hz - 20 kHz (± 0.5 dB)

Signal to noise ratio

106 dB or more when playing

Output level

2.0 volts r.m.s.

Power supply rating

AC 230 V, 50 Hz

AC 120 V, 60 Hz

Power consumption

11 watts (AC 230 V, 50 Hz)

13 watts (AC 120 V, 60 Hz)

Dimensions (W × H × D)

205 × 76 × 287 mm

Weight

2.3 kg

Specifications and features are subject to change without notice.

ONKYO CORPORATION

Sales & Product Planning Div.:2-1, Nisshin-cho, Neyagawa-shi, OSAKA 572-8540, JAPAN
Tel: 0720-31-8111 Fax: 0720-33-5222

ONKYO U.S.A. CORPORATION

200 Williams Drive, Ramesy, N.J. 07446, U.S.A.
Tel: 201-825-7950 Fax: 201-825-8150 E-mail: onkyo@onkyousa.com

ONKYO EUROPE ELECTRONICS GmbH

Industriestrasse 20, 82110 Germering, GERMANY
Tel: 089 84 93 20 Fax: 089 84 93 226 E-mail: info@onkyo.de

ONKYO CHINA LIMITED

Units 2102-7, Metroplaza Tower I, 223 Hing Fong Road, Kwai Chung, N.T., HONG KONG Tel: 852 2429 3118 Fax: 852 2428 9039

HOME PAGE
<http://www.onkyo.co.jp/>

SN29342793

Printed in Japan
D9907-1

